

CORE PRODUCT RANGE
SUSTAINABLE LUXURY GYM EQUIPMENT

P A R A G O N
S T U D I O 



Spring 2025



P A R A G O N
S T U D I O

London, UK

tel: +44 1225 727 959

hello@paragonstudio.co.uk | www.paragonstudio.co.uk





Introduction	6
Classic Range	16
Diabolo Dumbbells	
Luxury Kettlebells	
Weight Plates	
Leather Medicine Ball	
Adjustable Bench	
Folding Wall Bar	
Ballet Barre	
Wooden Plyo Box	
Skipping Rope	
Pilates Hand Weights	
Gym Rug	
Yoga Accessories	40
Cork Yoga Mat	
Cork Yoga Block	
Cork Yoga Roller	
Storage Solutions	48
Exercise Ball Holder	
Dumbbell Wall Rack	
Dumbbell Tree Rack	
Kettlebell Tree Rack	
Kettlebell Wall Rack	
Horizontal Dumbbell Rack	
Multistorage Rack	
Wall Unit Complete Package	
Wall Storage Hardware	
Credenza Complete Package	
Hand Weight Tree	
Boxing	72
Deluxe Leather Punch Bag	
Pro Leather Focus Pads	
Deluxe Leather Boxing Gloves	
Material Options	80
Custom Options	92
Case Studies	102
Partnerships	118
Technical Data	124
Designers Area	156

Introduction





At Paragon Studio we strive for perfection. Our luxury gym equipment is handcrafted in the UK using premium, sustainable materials.

We have perfected the art of combining the ergonomics of exercise with unparalleled beauty, where form follows function throughout our design. A truly British innovation, our goal is to offer sustainable and customisable gym equipment to the world - taking a bespoke approach that ensures every product is unique to each client.

Our Design Process

When we are working on developing new products for our range, our aim is to put function first and then design the form around it. This results in gym equipment that is more than just an ornament - each piece is made for tough workouts.

Once a product is ready to be prototyped, our engineers will begin to discuss how we can integrate sustainable materials and processes into the build in order to cut emissions.

Because each piece is made to order, our team are able to approach a project with a blank canvas and incorporate any bespoke requirements a client has during the pre-production phase.

This gives us unrivalled flexibility within our range, which is loved by clients and designers worldwide. As we continue to innovate and make unique changes to our products as requested by individual clients, we are continually learning new techniques and making improvements to our core product range.

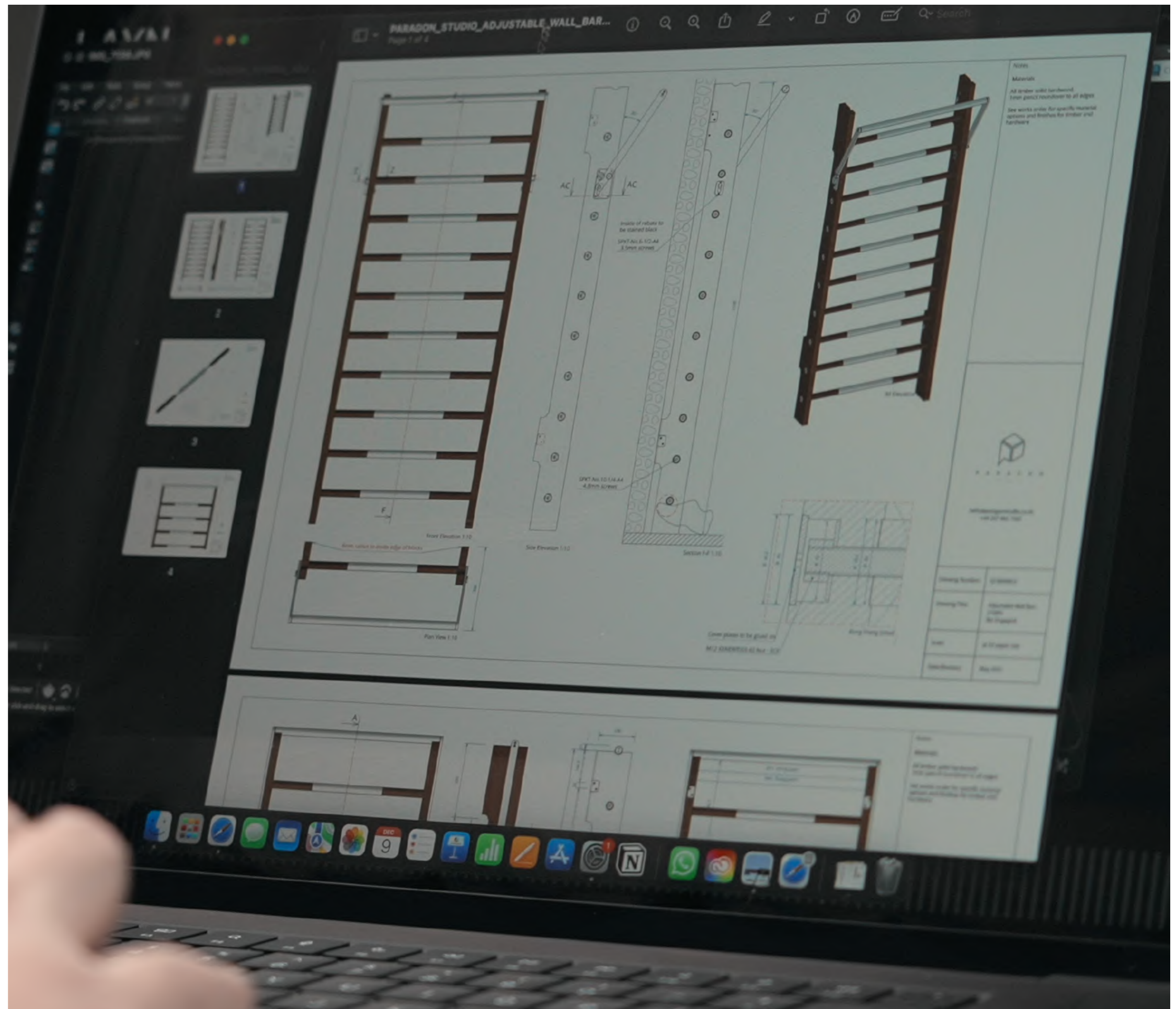

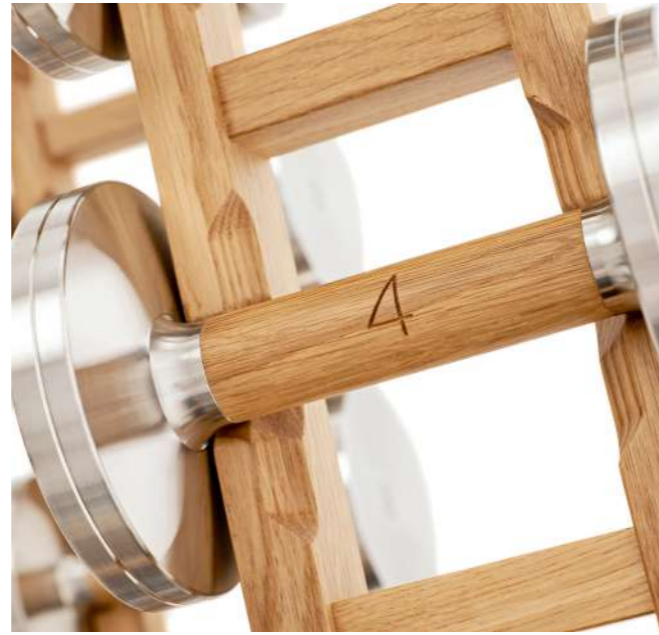
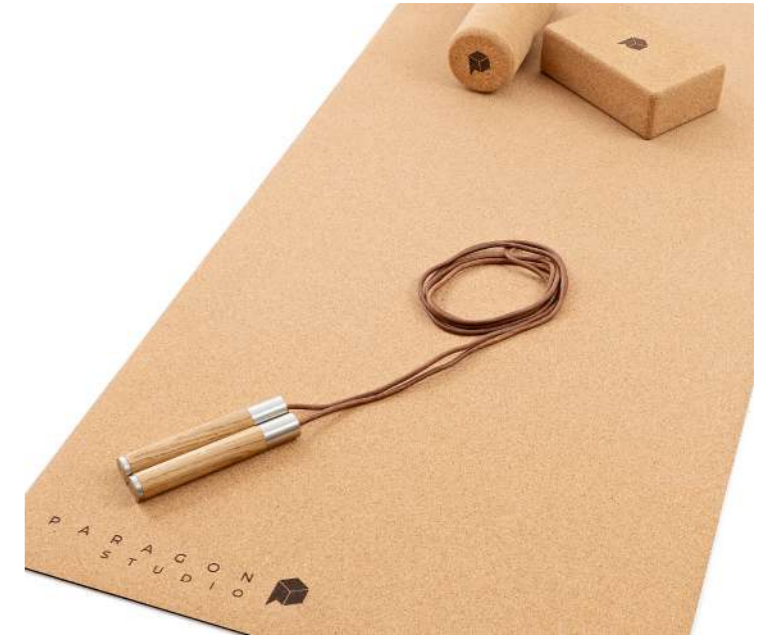

Route to Carbon Neutral

Our Diabolo Dumbbells are on the path to carbon negative. The inspiration behind our award-winning Diabolo Dumbbells was to produce a beautiful and high-quality dumbbell with sustainability at the forefront. While we know that our dumbbells are made from sustainably sourced materials and are 100% recyclable, we also wanted to be transparent about their environmental impact.

As such, we teamed up with an independent sustainability partner to commission a Carbon Footprint Report and establish the true environmental impact of our Diabolo Dumbbells. Carbon Managers has since carried out a thorough lifecycle assessment (LCA) study of all greenhouse gases and the converted CO₂ equivalents (CO₂e) associated with the manufacturing, packaging, distribution, use, and end of life, of the dumbbells.

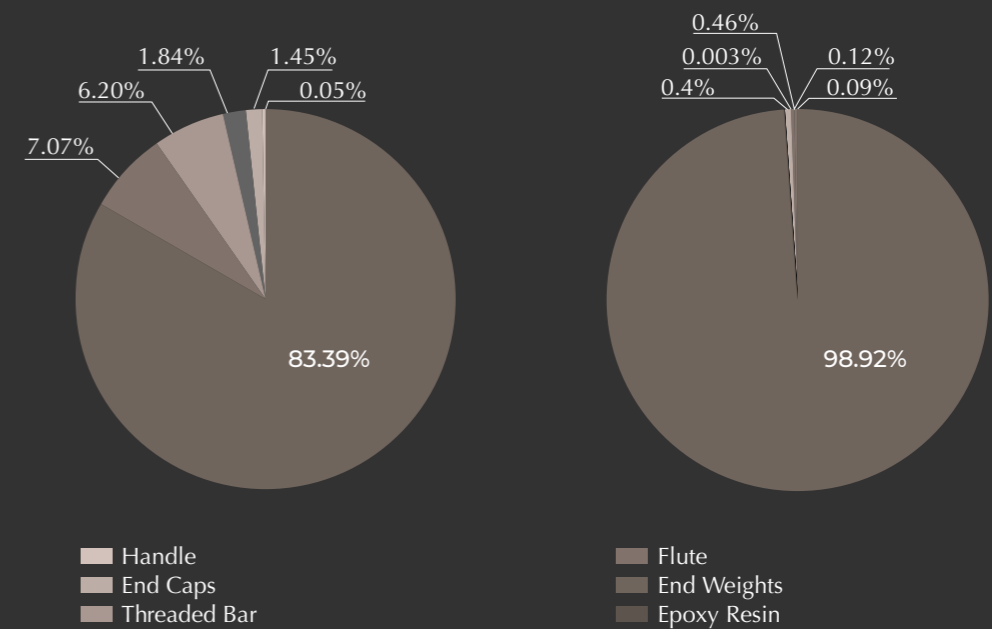
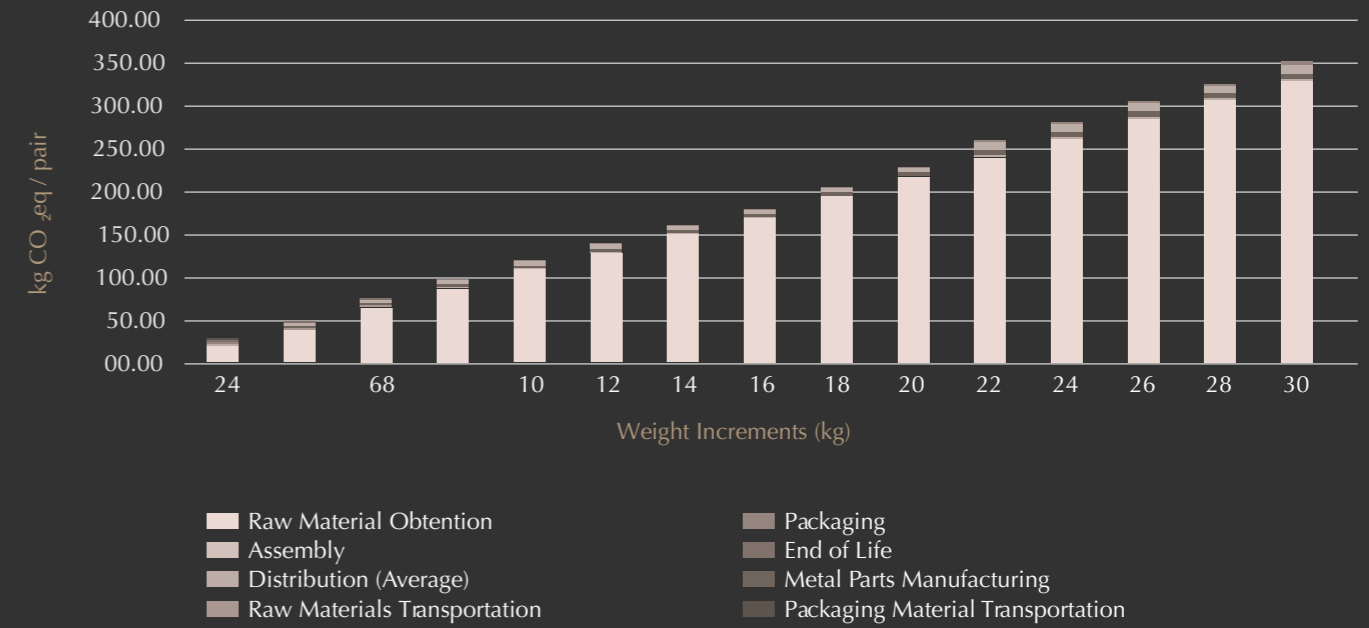

Classic Range





Diabolo Dumbbells

Our award winning Diabolo Dumbbells are the result of years of experience in the superyacht and prime property industries.

A truly over-engineered design - these dumbbells offer unparalleled levels of customisation and a uniquely concave end design. Choose our sustainable wooden handles and customise with laser engraving to add a touch of bespoke to your gym.

Wood Options



Oak

Iroko

Walnut

Blackwood

Metal Options



Stainless
Steel

Bronzed
Steel

Finishes

Brushed

Custom Options

Monogrammed end plates, bespoke staining

Sets Available

2-30kg (2kg increments), 5-50lbs (5lbs increments)

Prices from **£4,239**
(Ex VAT)



Luxury Kettlebells

Luxury Kettlebells made from stainless steel or aluminium bronze, with wooden inserts that can be matched to your interior. The smooth metal handle is the optimum solution for kettlebell swings, providing minimal friction during use and therefore a comfortable workout.

These kettlebells are sold in sets. Bespoke freestanding storage racks for your luxury kettlebells are also available in matching wood and metal finishes.

Wood Options



Oak

Iroko

Walnut

Blackwood

Metal Options



Stainless
Steel

Bronzed
Steel

Finishes

Brushed

Custom Options

Bespoke staining

Sets Available

Light: 4-10kg, Heavy 8-20kg



Prices from **£3,399**
(Ex VAT)



Weight Plates

Much like all our other products, the Paragon Studio Olympic Discs can be seamlessly customised for each individual client or space. Available in a variety of increments, that are designed to challenge serious workouts.

Starting at 5kg going through to 25kg, there's something for all. Your own bespoke logo can be added in place of our own if desired.

Wood Options



Oak

Iroko

Walnut

Blackwood

Metal Options



Stainless Steel

Bronzed Steel

Finishes

Brushed

Custom Options

Bespoke staining, add your logo

Sets Available

5kg, 10kg, 20kg

Prices from **£3,399**
(Ex VAT)



Leather Medicine Ball

Our Classic Leather Medicine Balls are hand-stitched from the finest genuine leather. These tools are perfect for strength training and rehabilitation exercises.

Functional with a luxurious retro design, you can add a heat-embossed logo and choose from two colour options to beautifully present these balls in any premium gym.

Leather Options



Tan

Brown

Black

Custom Options

Heat embossed logo



Prices from **£520**
(Ex VAT)

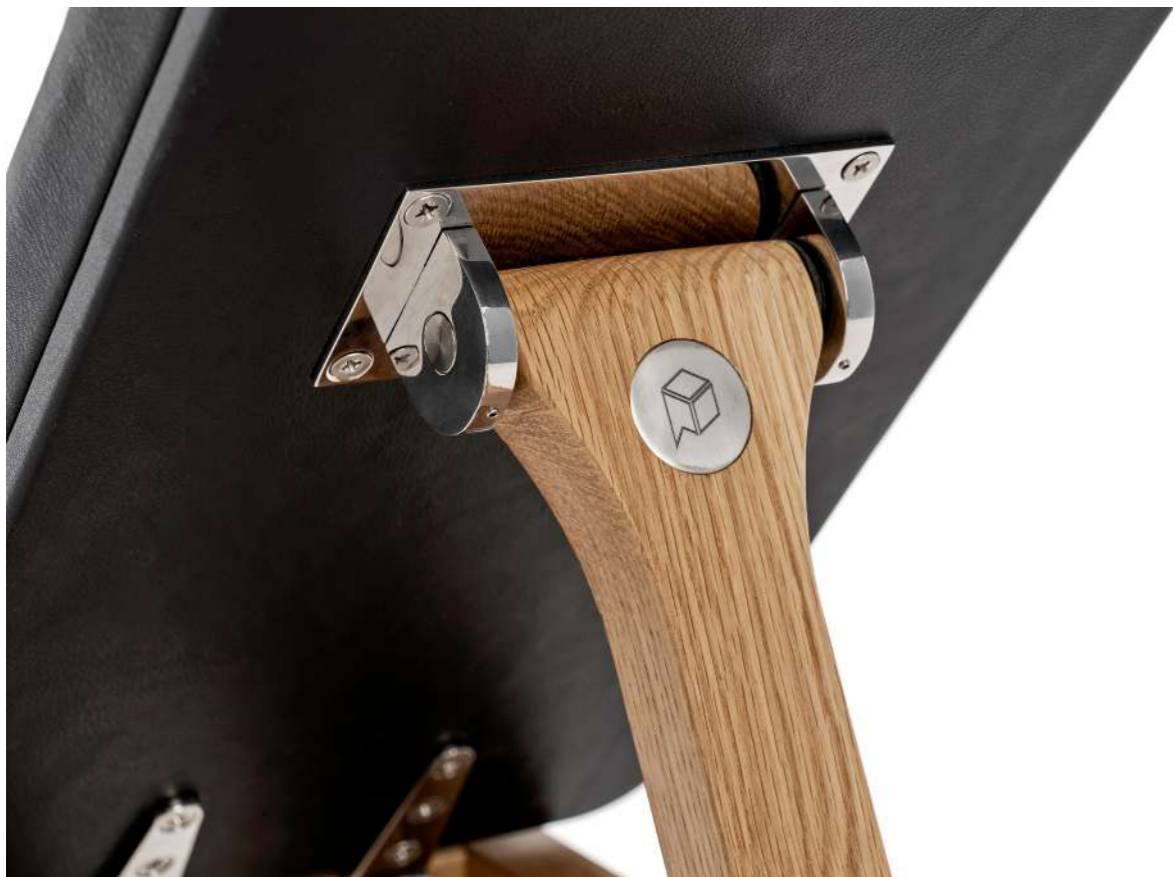

Adjustable Bench

Made for stability and strength, our bench is designed around functional use and serious workouts. The four point frame and unique bone-shaped rear arm is the product of years of experience within our design team.

Clients can choose from our standard selection of leather upholstery with contrast stitching, or provide their own to match another finish in their interior.

Wood Options



Oak Iroko Walnut Blackwood

Metal Options



Stainless Steel Bronzed Steel

Leather Options



Tan Brown Black

Finishes

Brushed or Polished

Custom Options

Your choice of leather, bespoke staining

Configurations

Adjustable, flat

Prices from **£2,789**
(Ex VAT)



Folding Wall Bar

A multifunctional and flexible training solution, with a folding top bar for suspension and body weight training. Crafted with sumptuous materials, each rung features a central steel sleeve allowing for a contrasting smooth surface against the wood.

Wood Options



Oak

Iroko

Walnut

Blackwood

Metal Options



Stainless
Steel

Bronzed
Steel

Finishes

Brushed or Polished

Custom Options

Bespoke staining

Configurations

Folding, short, fixed

Prices from **£5,159**
(Ex VAT)



Ballet Barre

Available in single and double configuration, these popular accessories for home gym rooms will be made in finishes to match the rest of our range.

Bespoke sizing and finishing for both the metal and wood elements is possible; with custom staining on the wood and PVD coatings or powder coat for metal brackets.

Wood Options



Oak Iroko Walnut Blackwood

Metal Options



Stainless Steel Bronzed Steel

Finishes

Brushed or Polished

Custom Options

Bespoke staining

Prices from **£POA**
(Ex VAT)



Wooden Plyo Box

Constructed from sustainable wood for a strong yet beautiful design, this multifunctional piece of equipment allows for training progression with its three possible height options.

The box is fully customisable as natural oak can be stained to match any joinery in the gym and throughout the interior.

Wood Options



Oak

Iroko

Walnut

Blackwood

Custom Options

Bespoke staining



Prices from **£1,489**
(Ex VAT)



Skipping Rope

The Paragon Studio weighted Skipping Rope will test your upper body strength for a challenging workout. The handles are made with premium wood and stainless steel hardware with an aged leather rope for a truly unique design. The length of the rope is customisable, simply use the thumb screw at the base of each barrell to smoothly adjust the length. This skipping rope has been beautifully designed to compliment all fitness capabilities.

Wood Options

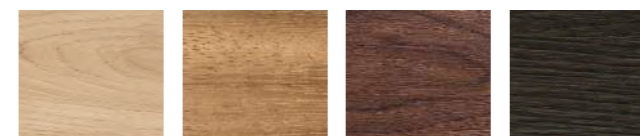

Oak

Iroko

Walnut

Blackwood

Metal Options



Stainless
Steel

Bronzed
Steel

Finishes

Brushed or Polished

Custom Options

Bespoke staining



Prices from **£150**
(Ex VAT)



Pilates Hand Weights

Our hand weights kit is a neat set of pilates hand weights designed to be used for toning and light weight exercises.

The 1, 2 and 3kg hand weights are stored on a portable rack, which can be displayed on a tabletop or shelf in the gym. This also includes a carry handle so the hand weights could be taken outside or to another workout location.

Wood Options



Oak

Iroko

Walnut

Blackwood

Metal Options



Stainless
Steel

Bronzed
Steel

Finishes

Brushed

Sets Available

Available also in 1kg - 10kg with a dumbbell tree

Prices from **£995**
(Ex VAT)



Gym Rug

Introducing our exclusive performance Rug Collection, designed to bring sophistication, durability, and functionality to elite gym spaces.

Inspired by our clients, this product allows Interior Designers and homeowners to specify their preferred timber floors in their gym spaces – providing a seamless and customisable alternative for loose laid rubber floor tiles required to protect the wood in the freeweights area.

The collection features rugs crafted from Polypropylene (PP) yarn, known for its exceptional resilience and easy to maintain nature. Developed in a range of refined hues including brown, charcoal and blue and constructed in a high performance loop texture that adds elegance to any gym.

Rugs can be specified in any shape or size, and a 2mm non-slip layer is provided underneath for extra security. Our rugs are washable and can even be bleached.



Prices from **£700 p/m²**
(Ex VAT)

Yoga Accessories





Cork Yoga Mat

Made from sustainable materials, the Cork Yoga Mat offers unparalleled quality in recycled, sustainable and biodegradable materials. It is beautifully crafted with a natural rubber base, ensuring a non-slip and injury free experience during floor workouts.

Options



Cork

Prices from **£80**
(Ex VAT)



Cork Yoga Block

Our Yoga Block provides a smooth and comfortable experience for finding the correct alignment during yoga practices. Made from sustainable cork, it ensures a non-slip surface during practice and a beautiful finish.

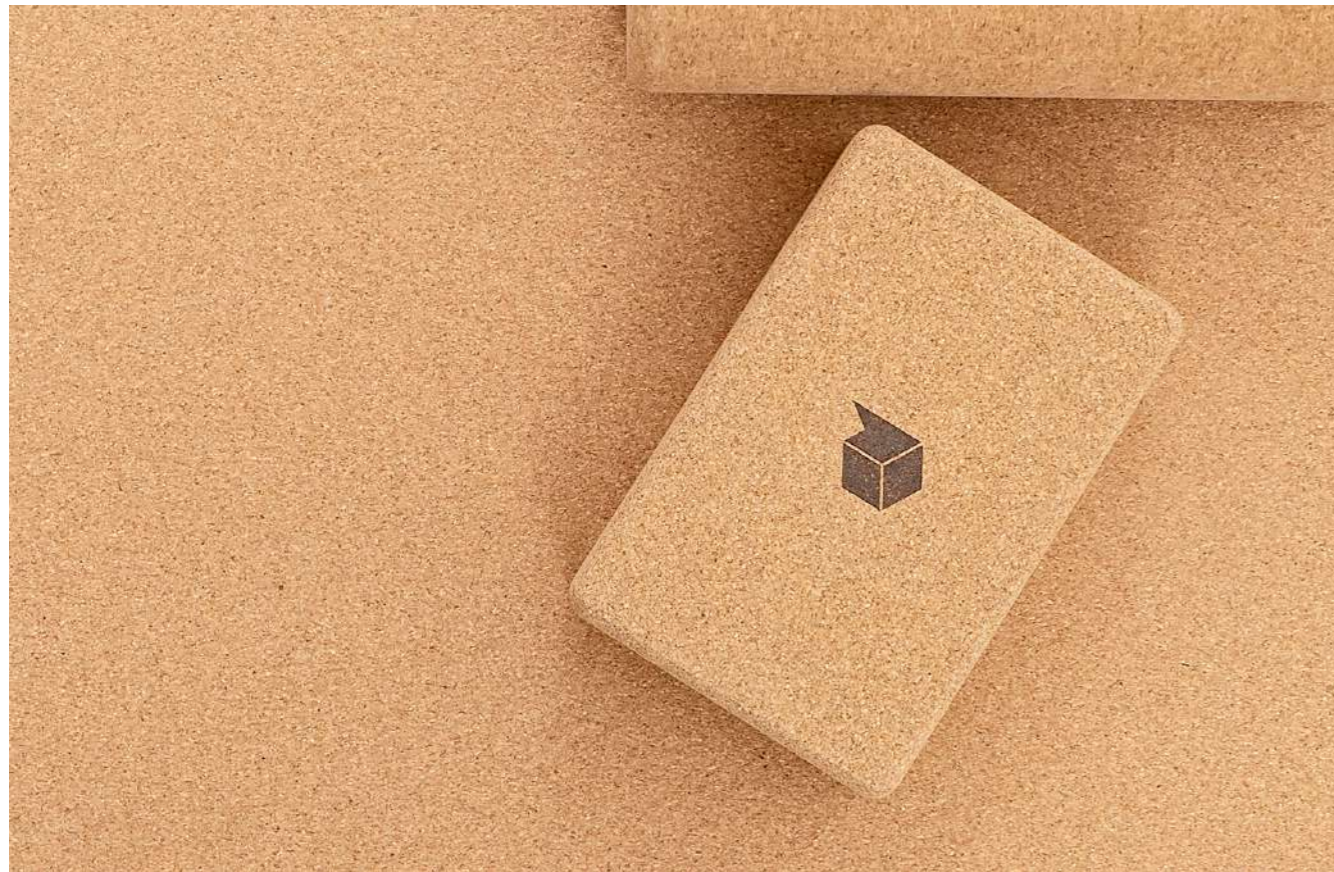

Options



Cork

Prices from **£30**
(Ex VAT)



Cork Yoga Roller

This roller has been beautifully designed to provide unmatched support and alignment during practices. Crafted from sustainable materials, the Paragon Studio Cork Yoga Roller can be used for balancing, stretching and reclining.

The high-density cork boasts a natural, hard surface that provides a deep-tissue massage, constantly developing and supporting your movements.

Options



Cork

Prices from **£30**
(Ex VAT)



Storage Solutions





Exercise Ball Holder

The Paragon Studio Exercise Ball Holder allows exercise balls to be stored with pride and prevents rolling around the gym when not in use.

Crafted from premium natural wood and metal, it is customisable to complement any stylish exercise ball which is chosen to sit within it.

Wood Options



Oak

Iroko

Walnut

Blackwood

Metal Options



Stainless
Steel

Bronzed
Steel

Custom Options

Custom engraving available



Prices from **£1,499**
(Ex VAT)



Dumbbell Wall Rack

Our Wall Mounted Dumbbell Column beautifully presents and securely holds Diabolo Dumbbells in place when not in use. Each rack is bespoke, using materials found on the dumbbells and throughout the gym design.

This luxury space saving solution ensures ease of accessibility for each weight and great aesthetics.

Wood Options



Oak

Iroko

Walnut

Blackwood

Metal Options



Stainless
Steel

Bronzed
Steel

Finishes

Brushed or Polished

Custom Options

Bespoke staining

Sets Available

3 pair, 4 pair, 5 pair

Prices from **£1,379**
(Ex VAT)



Dumbbell Tree Rack

Creating space saving solutions is a top priority for our design team, so our dumbbell tree requires minimal floor space whilst maintaining optimum stability.

Made from the same top quality materials, the free weights and rack beautifully blend together and add a sculptural element to any gym design project.

Wood Options



Oak

Iroko

Walnut

Blackwood

Metal Options



Stainless Steel

Bronzed Steel

Finishes

Brushed or Polished

Custom Options

Bespoke staining

Sets Available

5 pairs, 6 pairs

Prices from **£2,029**
(Ex VAT)

Kettlebell Tree Rack

The ultimate solution for stylish and efficient kettlebell storage. Our Kettlebell tree Rack is designed to hold 4 or 6 luxury kettlebells vertically; this exquisite rack is perfect for maximising space in your gym while adding a touch of sophistication.

The rack's small footprint makes it an ideal choice for any gym size, offering both functionality and style without compromising on space.

Wood Options



Oak

Iroko

Walnut

Blackwood

Metal Options



Stainless Steel

Bronzed Steel

Finishes

Brushed or Polished

Custom Options

Bespoke staining

Sets Available

2 pair, 3 pair

Prices from **£3,127**
(Ex VAT)





Kettlebell Wall Rack

Mounted on the wall, the Paragon Studio Kettlebell Storage Column offers a sleek, space-efficient solution that ensures easy access to each weight.

Crafted with the same premium materials as our kettlebells, the Paragon Studio Wall Rack enhances the sophisticated, luxury feel of your workout space.

Wood Options



Oak

Iroko

Walnut

Blackwood

Metal Options



Stainless
Steel

Bronzed
Steel

Finishes

Brushed or Polished

Custom Options

Bespoke staining

Sets Available

3 pair, 4 pair, 5 pair



Prices from **£2,340**
(Ex VAT)



Horizontal Dumbbell Rack

Our racks are crafted to enhance the detailed design of our dumbbells, keeping them secure for all to admire. Designed to stand freely within the most beautifully designed environments, clients also have the option of integrated rear wall fixing brackets.

One size won't fit all, so our racks can be adapted to any space.

Wood Options

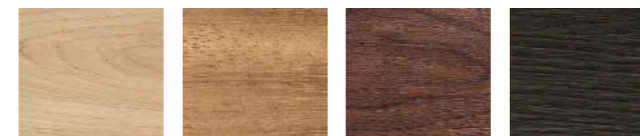

Oak

Iroko

Walnut

Blackwood

Metal Options



Stainless
Steel

Bronzed
Steel

Finishes

Brushed or Polished

Custom Options

Made to measure configuration, bespoke staining

Sets Available

5 pair, 6 pair, 10 pair, 15 pair

Prices from **£2,779**
(Ex VAT)

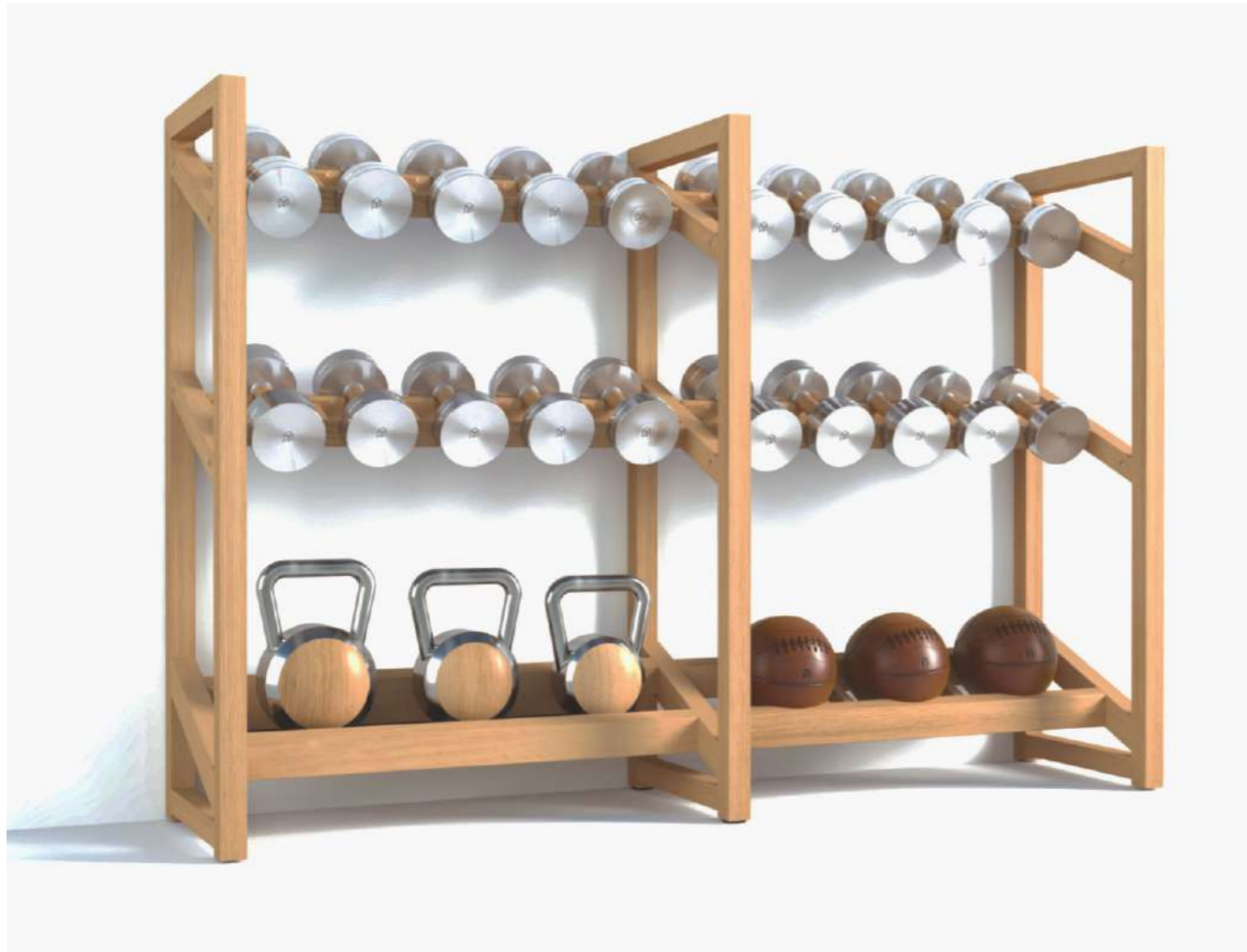

Multistorage Rack

Our Multistorage Rack is a 3 tier version of our Horizontal Rack, which has been designed to hold a combination of dumbbells, kettlebells and medicine balls.

Wood Options



Oak Iroko Walnut Blackwood

Metal Options



Stainless Steel Bronzed Steel

Finishes

Brushed or Polished

Custom Options

Made to measure configuration, bespoke staining

Sets Available

It holds 10 pairs of dumbbells and can be configured to hold either 6 kettlebells, 6 medicine balls, or a combination of 3 medicine balls and 3 kettlebells on the lower shelf.



Prices from **£6,760**
(Ex VAT)



Wall Unit Complete Package

A space-saving and bespoke modular wall hanging unit that beautifully displays your equipment. The materials and finishes of the whole configuration can all be customised to seamlessly match your interiors. All accessories are securely stored via steel brackets or the neat storage boxes within the base.

A standard kit includes 2-12 Paragon Studio Diabolo Dumbbells, 2 Paragon Studio Classic Leather Medicine Balls, 2 Paragon Studio Cork Yoga Mats, 2 Paragon Studio Cork Yoga Blocks, Nord Eau Me Balance Board, Vluv Veel Exercise Ball, Paragon Studio Skipping Rope, Exercise/Stretching Bands.

Wood Options



Oak Iroko Walnut Blackwood

Metal Options



Stainless Steel Bronzed Steel

Finishes

Brushed or Polished

Custom Options

Made to measure configuration, bespoke staining

Sets Available

1 panel, 2 panel, 3 panel

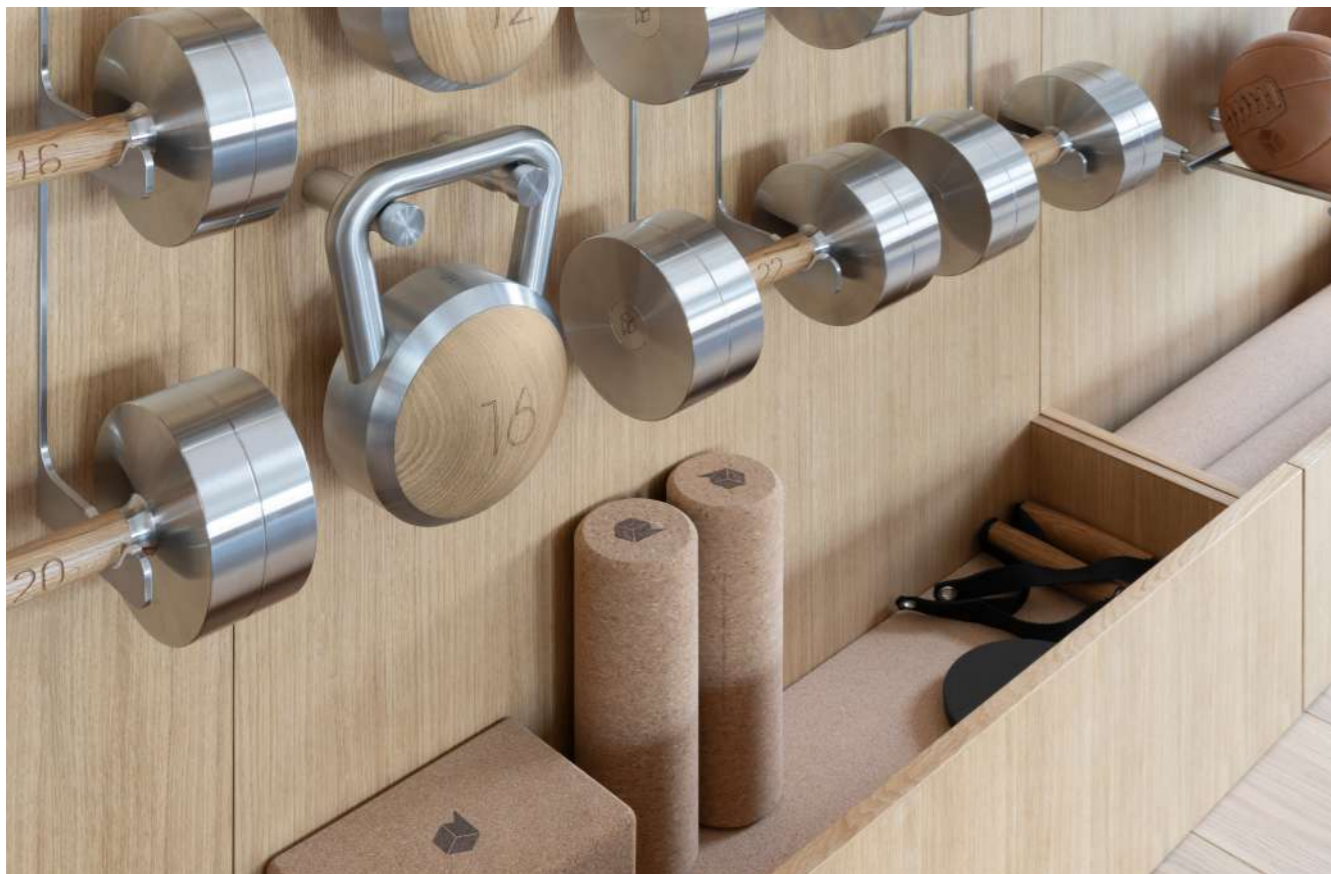

Prices from **£7,695**
(Ex VAT)



Wall Storage Hardware

Our unique metal brackets we use to store freeweights and accessories on our wall units are now available for purchase! These are some of our most in demand pieces, and are perfect for integration into bespoke joinery planned for your gym space.

Metal Options



Stainless
Steel

Bronzed
Steel

Finishes

Brushed or Polished



Prices from **£POA**
(Ex VAT)

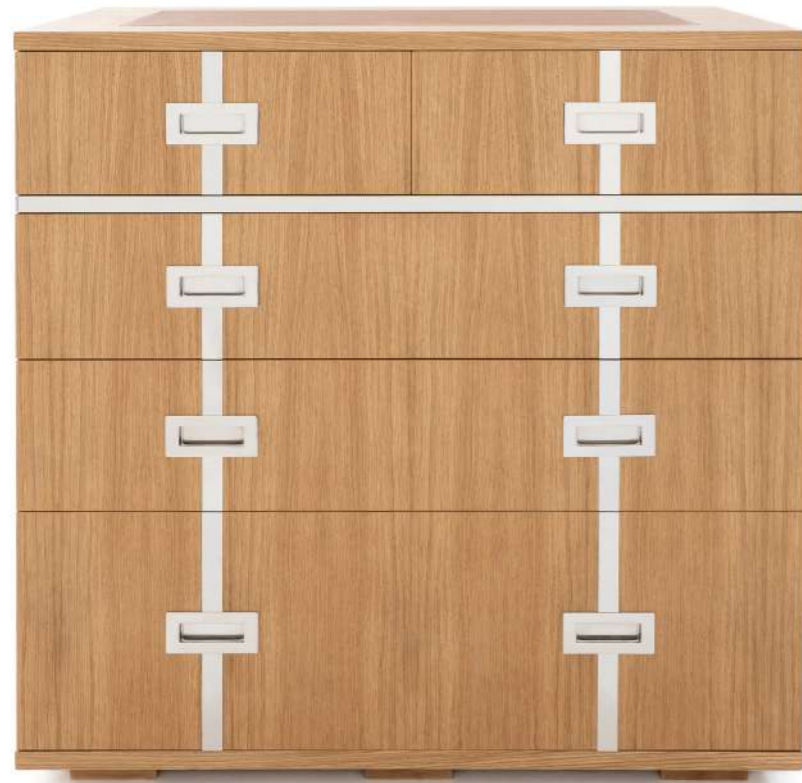

Credenza Complete Package

Our Credenza is a customisable, freestanding storage unit for small gym weights and accessories. Bespoke set-outs are available for each drawer, designed solely around the Paragon Studio range.

Our workshop use hand-flocked inserts to hold equipment in place inside the drawers, and the unit is configured so as to allow maximum capacity for storing all the items you would need for a great workout. Each drawer uses a soft-close mechanism and can also have a locking latch at both ends in the event the unit will be used at sea.

Wood Options



Oak Iroko Walnut Blackwood

Metal Options



Stainless Steel Bronzed Steel

Finishes

Brushed or Polished

Custom Options

Made to measure configuration, bespoke staining



Prices from **£7,695**
(Ex VAT)

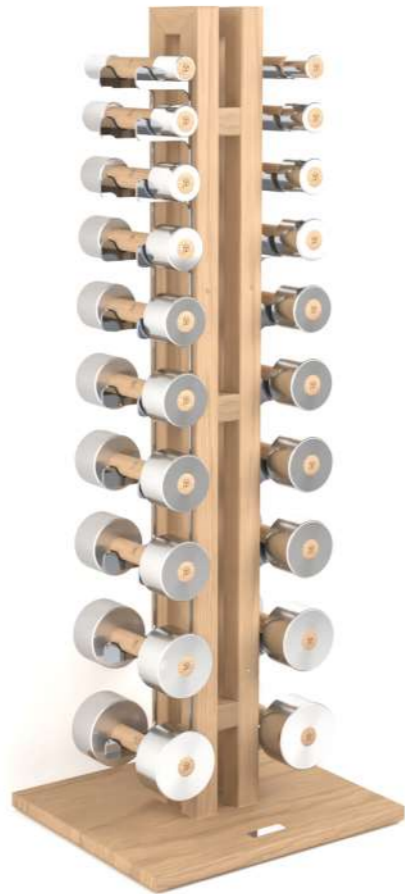

Hand Weight Tree Rack

Introducing the Paragon Studio Luxury Hand Weights, where exceptional craftsmanship meets unparalleled design. Crafted for those who value both form and function, these hand weights are a stunning addition to any fitness regimen, offering a seamless blend of luxury and performance.

For those who seek a harmonious display, an optional freestanding rack is available, crafted in the same exquisite finishes to perfectly match your hand weights. This elegant rack not only provides convenient storage but also transforms your weights into a work of art, making them a striking addition to any home gym or living space.

Wood Options



Oak

Iroko

Walnut

Blackwood

Metal Options



Stainless Steel

Bronzed Steel

Finishes

Brushed or Polished

Custom Options

Bespoke staining

Prices from **£9,100**
(Ex VAT)

Boxing





Deluxe Leather Punch Bag

A bag which has the perfect balance between strength and style whilst complementing the interiors within a luxury gym. Made with natural cowhide leather for a dependable and bespoke boxing experience.

Bags are available in a range of sizes and weights, with the option of a heat-embossed logo.

Leather Options

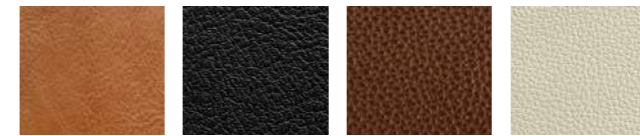

Tan

Black

Brown

Cream

Custom Options Heat embossed logo

Prices from **£420**
(Ex VAT)



Pro Leather Focus Pads

Created to an exceptional standard for strength and durability during training, and composed of natural leather and sustainable materials.

Available in one size with an adjustable strap. Customise with your own heat-embossed branding onto the pad, and choose your leather.

Leather Options

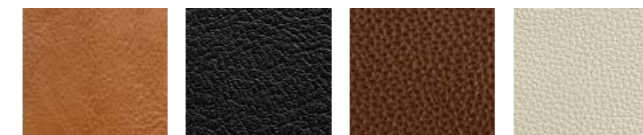

Tan Black Brown Cream

Custom Options Heat embossed logo

Prices from **£220**
(Ex VAT)



Deluxe Leather Boxing Gloves

A beautiful, vintage design that maintains all the classic features of a great boxing glove.

Double stitching across the gloves withstands even the hardest of punches, and a triple layer foam padding absorbs the impact of each punch.

Leather Options

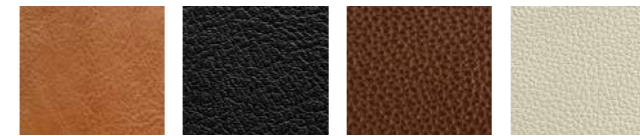

Tan

Black

Brown

Cream

Custom Options Heat embossed logo

Prices from **£220**
(Ex VAT)

Material Options



Material Options

At Paragon Studio, we offer clients bespoke equipment across our entire collection. Alongside our standard selection of materials, our range of products can be made in any wood or metal finish you can imagine.

We encourage clients and designers to suggest their own material finishes for each individual component of the equipment, carefully matching and sampling new techniques where necessary to improve the final product.





Woods



Oak

Elegant and classic, our European Oak is sourced from sustainable forests. The beautiful wood grain has a natural pattern, making each piece unique.



Iroko

A warm and rich wood, which is elegant and durable. We use Iroko in place of traditional Teak to ensure sustainable and ethical sourcing.



Walnut

Prized for its strength and durability, American Walnut has a velvety finish in its grain and a rich brown colour.

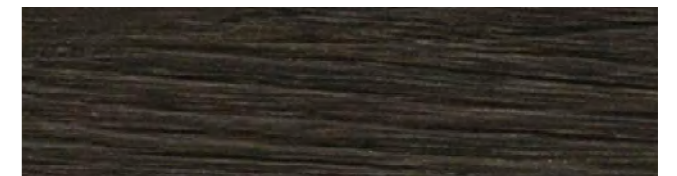

Blackwood

Deep black stained Oak which allows the natural wood grain to show through. Hand finished in the UK, this material holds its colour to stand the test of time.

Metals



Stainless Steel

Elegant and hardwearing, Steel offers a uniform and highly reflective finish which compliments all interiors. Turned or polished with an elegant shine.

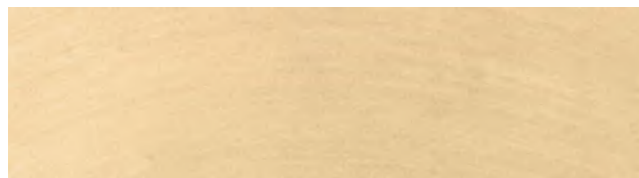

Bronzed Steel

A popular gold hue that is delicate yet opulent. Eclectic warm tones will tie your gym design together. We use Aluminium bronze or PVD coating to achieve this look.

Finishes

Brushed

A textured and understated metal finish. Offers an all-purpose, textured effect that gives the metal a smooth, unidirectional appearance.

Polished

Hand treated metal with a highly-polished mirror finish characterised by a bright, shiny and reflective surface.

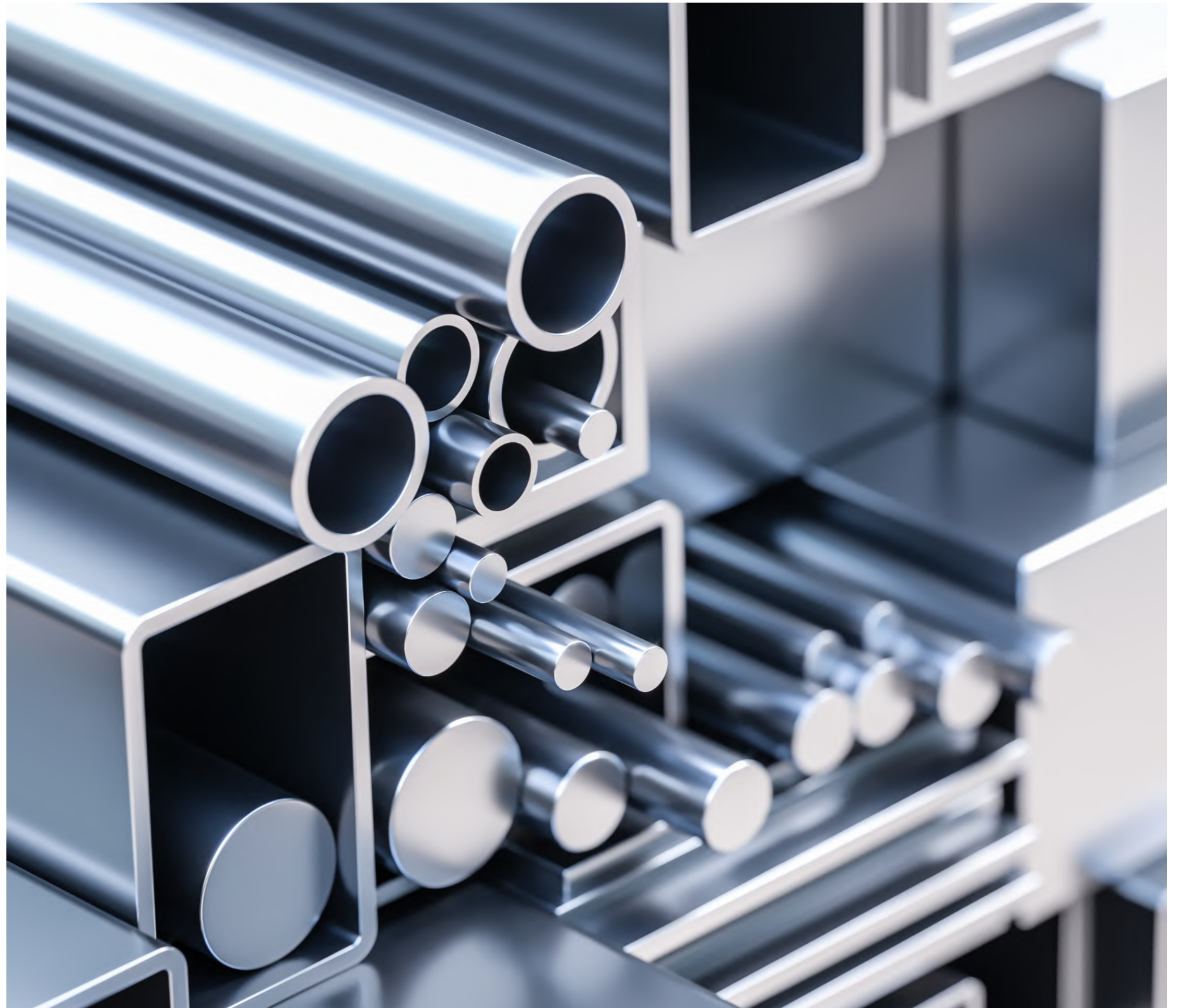



Leathers



Tan

A sustainably sourced durable leather. Rich and velvety in colour, robust against cracking and wear, it gets better with time.



Black

A classic and timeless leather finish. Features a soft sheen that accentuates the textured appearance of the leather.



Brown

Easy to clean and condition, protecting against damage. Rich and earthy tones with a textured matte finish, a classic and subtle leather.



Cream

A rich and natural leather that resists fingerprints and scuff marks. Its light structure gives it an exceptionally soft, velvet-like texture.

Cork



Natural Cork

A sustainable and soft finish for yoga equipment, cork offers low density cushioning. The perfect lightweight and durable material.



Custom Options





Custom Options

At Paragon Studio, our goal as a business is to combine the ergonomics of exercise with an aesthetic consideration which sets our gym designs apart from the average workout area. As a team, we have years of experience in creating highly desirable spaces, we go above and beyond creating customisable and bespoke pieces of equipment that are unique to each individual interior and client.



We recently completed our most ambitious project yet for some fantastic London based clients in their basement home gym. We were able to custom stain the wood on their equipment to seamlessly extend their already established interior aesthetics. Everything was chosen to coherently match and complement the design.

This project was completed for a major UK interior design firm who requested we use a mismatched wood for the dumbbell handles and racks.

A bespoke bleached Oak was used for the racking, and for the dumbbell handles our American Walnut was chosen.

As seen here on this project, if required, the end plates can be laser engraved so that weight increments can be clearly displayed in the centre of the surface. Equally, rubber bands can easily be incorporated around the discs of your weights. These bands protect both your weights and flooring from damage during use.



Case Studies



Idea House

The Southern Living Magazine Idea House, with an interior designed by Laura Hodges, opened in August 2023 in Nashville TN.

The house took star position as the Cover Story in the September issue of the magazine, which also featured an in depth interview with country music sensation Thomas Rhett.

Our gym forms part of the home's extensive leisure and well-being offering, bathed in natural light and indulged by huge windows which bring the bucolic exterior in.

The house was opened for tours in Thompson's Station TN through December 17th 2023, and showcases a harmonious blend of modernity, sustainability, and the unmistakable charm of Tennessee.





OWO Penthouse

The OWO Penthouse has been designed by international studio Winch Design, who combine their decades of experience in creating superyacht, private aircraft and residences for ultra-high net worth clients, with a timeless and joyful scheme that champions craftsmanship, artistry and The OWO's historical and cultural significance.

In the design of the five-bedroom lateral penthouse, Winch collaborated with over forty award-winning suppliers to craft and source bespoke pieces of furniture, fabrics, artwork and accessories, creating a residence that feels carefully curated over time. Featuring a private gym and sauna, cinema and games room, staff quarters and expansive terraces with panoramic views, The OWO Penthouse is a truly one-of-a-kind residence.

We were delighted to outfit the gym space with equipment from our range, and the beautiful NoHrd Bike in Oak.

The Manchester Hotel

Working with the hotelier and his design team, Paragon Studio were delighted to be involved in this boutique gym project right in the heart of Lexington's famous Bourbon district.

The gym replicates the incredible finishes incorporated throughout the hotel; built to mirror Kentucky's unbridled enthusiasm, warm Southern light, and full-galoped feeling.

Our team worked on the gym layout design, and created a kit list including Paragon Studio Adjustable gym benches and Boxing equipment with the hotel logo debossed into the leather pads. We also specified Diabolo Dumbbells with the logo laser engraved into the end plates, matching racks and cork yoga equipment.

Lastly, Peloton and Precor were brought in to the project to complete the cardio and strength offering.

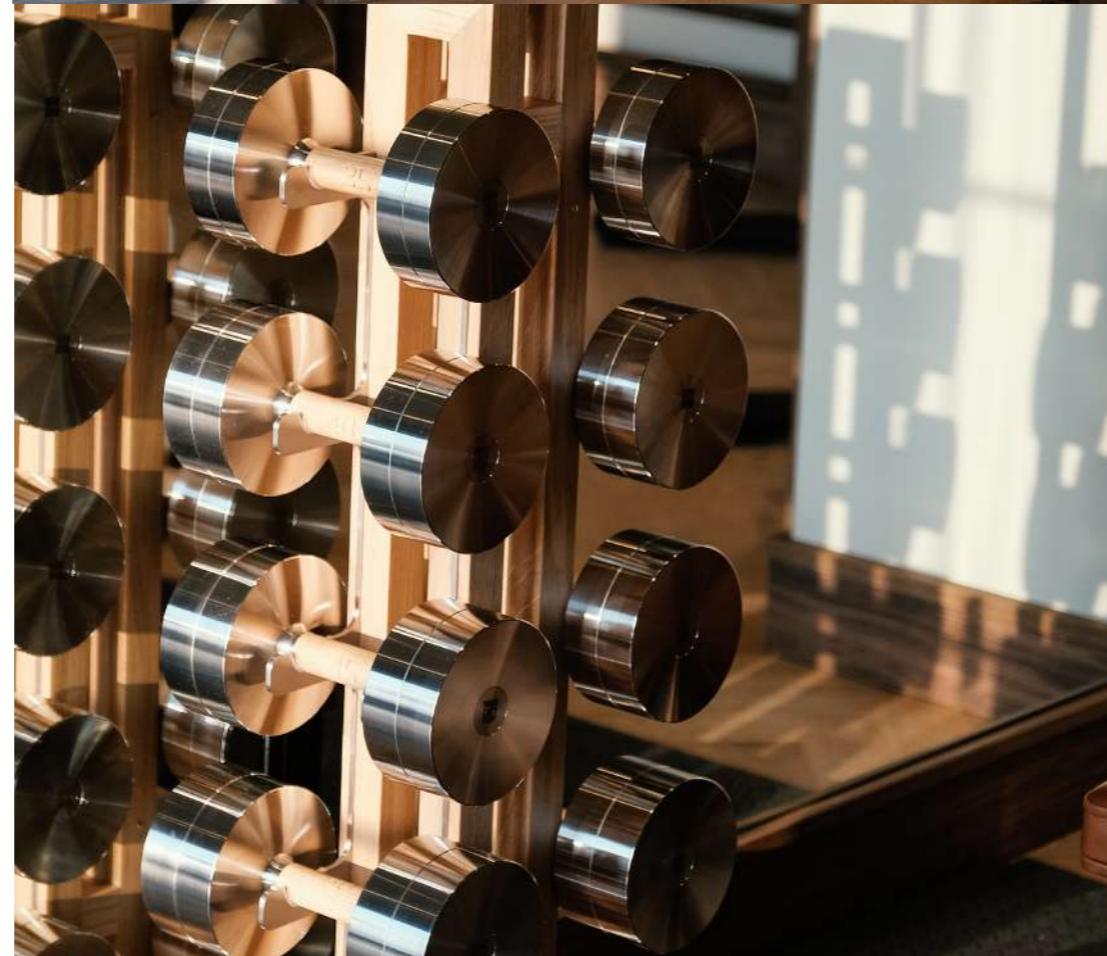



The Royal Hotel

This luxury hotel gym in Picton, Ontario was opened to guests in late 2022.

The space forms part of an incredible wellness offering, and features a number of our products.

Seen here is our Folding Wall Bar and Adjustable Bench, which were supplied along with a Wooden Plyo Box and Exercise Ball Holder. We were contracted by the hotel's interior designer to deliver these products towards the end of a long refit.

The products were made in American White Oak in order to match the same material used throughout the interior of the property.

Arabian Ranches, Dubai

Nestled in a quiet corner in the Arabian Ranches neighbourhood, this effortlessly stylish home gym is the latest addition to a family home which has undergone an extensive redevelopment.

The owner was particularly forward thinking in the use of wall space to keep the floor area tidy, and our vertical wall storage options for free weights therefore suited the design perfectly. The level of organisation in this gym is seriously impressive; every item has a hook or a dedicated storage box right down to individual pairs of gym trainers.

Overall this is a stunning space and we are very grateful to this wonderful family for allowing us to play a small part in their amazing home!





Chelsea Home Gym

This beautiful duplex apartment in London was totally refitted by its owner in the Summer of 2023.

Originally 2 separate dwellings, the properties were connected and turned into a single home for a client who frequently travels internationally for business, but has a passion for staying healthy.

Paragon Studio were commissioned to do a complete design of the gym including provision of bespoke equipment in Oak and Steel; and recommendation of supplementary accessories and flooring.

For this ambitious project we created our first triple wall storage unit – with a new module to hold both dumbbells and kettlebells. This has now become a staple within our range of configurable storage options.

A NoHrd Slim Beam, also in Oak, completes the gym with a smart and compact cable training facility.



Tuscany Villa

This Tuscan Villa is owned by a family who are enthusiastic about their training and have gyms in their properties around the world. The project we completed in late 2023 with Pippa Paton Design.

The standout feature of this converted garage gym is the set of enormous glass doors at the front; letting in the light and allowing fresh air to flood into the gym during the summer months when they are open.

Our equipment was specified in Oak and Steel, with heritage brown and tan leathers being chosen to meet the design brief.



Partnerships



Millimetres 2 Mountains Foundation

We are thrilled to announce that we will be working with the Millimetres 2 Mountains Foundation as our nominated charity for 2025.

Millimetres 2 Mountains creates positive change for individuals who have experienced life-changing trauma through the healing powers of the great outdoors. Founded by Ed and Lois Jackson, the charity supports its community with opportunities for global trips and challenges, life coaching, physio, career grants, UK walks, wellness retreats and more.





Showroom Locations

We're thrilled to announce our partnership with Linley London, bringing Paragon Studio's distinctive, award-winning designs to the streets of Belgravia, London.

Now, you can explore our collection—including the Diabolo Dumbbells and Deluxe Leather Boxing Gloves—at the prestigious Linley Belgravia showroom.

As well as this partnership, we also have showrooms to visit globally, including:

- HQ - Bath, UK
- Glancy Fawcett in Old Trafford - Manchester, UK
- National Marine in Fort Lauderdale - Florida, USA
- Finasi Interiors - Dubai, UAE

Equipment also on display with:

- VUORI Regent Street - London, UK
- VUORI Kings Road - London, UK

Technical Data

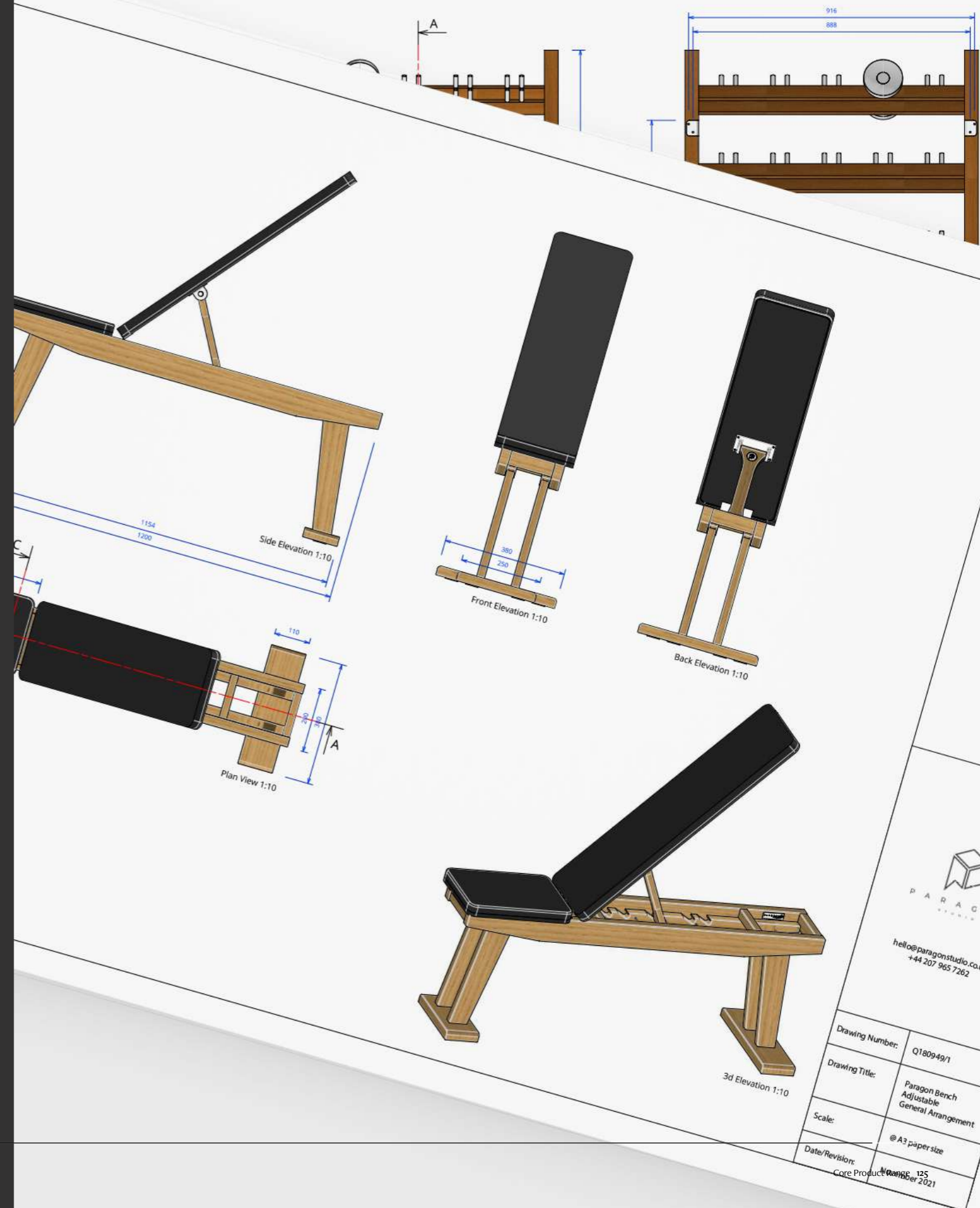

Diabolo Dumbbells

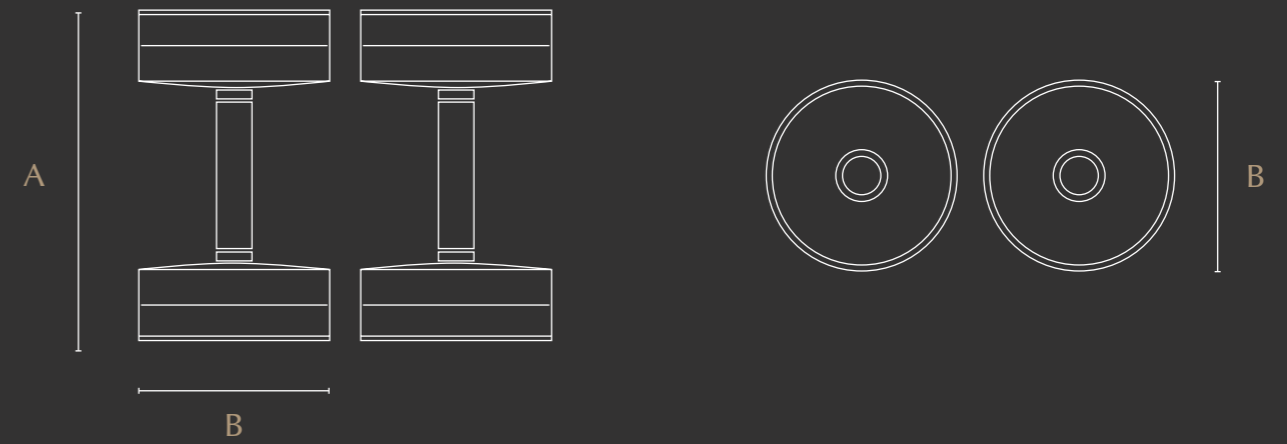

	Dimension A	Dimension B
2kg	165mm	125mm
2.5kg	170mm	125mm
4kg	185mm	125mm
6kg	206mm	125mm
7.5kg	221mm	125mm
8kg	226mm	125mm
10kg	247mm	125mm
12kg	267mm	125mm
12.5kg	272mm	125mm
14kg	287mm	125mm
16kg	262mm	150mm
17.5kg	273mm	150mm
18kg	277mm	150mm
20kg	290mm	150mm
22kg	305mm	150mm
22.5kg	308mm	150mm
24kg	319mm	150mm
26kg	333mm	150mm
27.5kg	343mm	150mm
28kg	347mm	150mm
30kg	349mm	150mm
32.5kg	379mm	150mm

Luxury Kettlebells

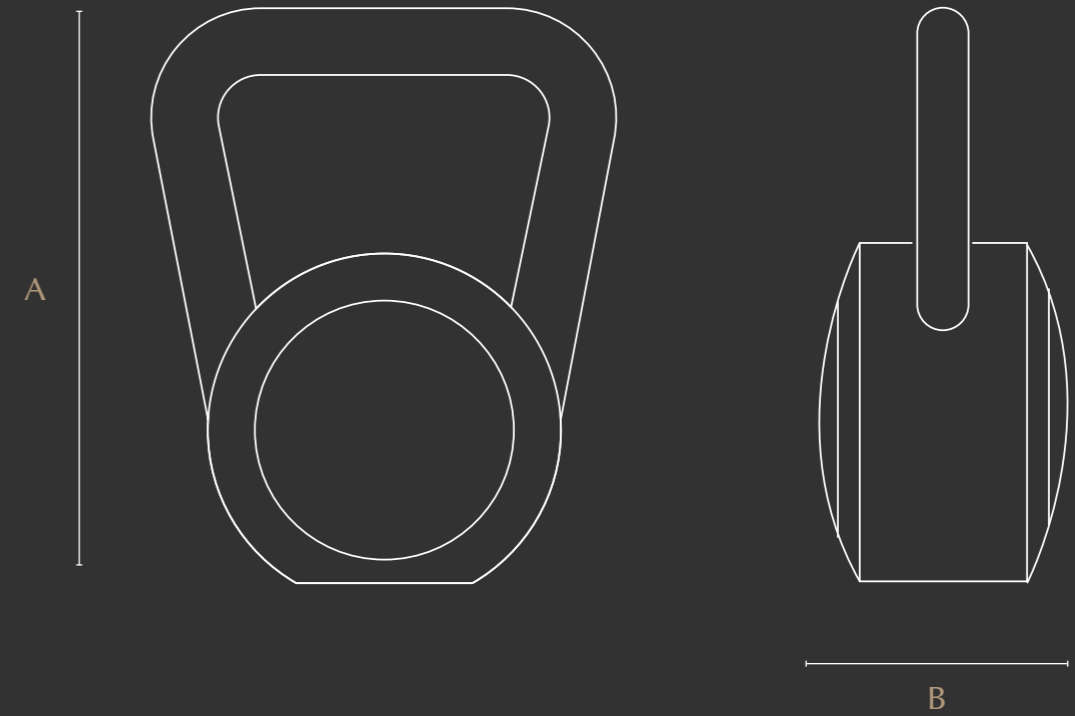

	Dimension A	Dimension B
4kg	220mm	86mm
6kg	224mm	92mm
8kg	237mm	106mm
10kg	241mm	106mm
12kg	261mm	130mm
16kg	280mm	130mm
20kg	300mm	155mm

Weight Plates

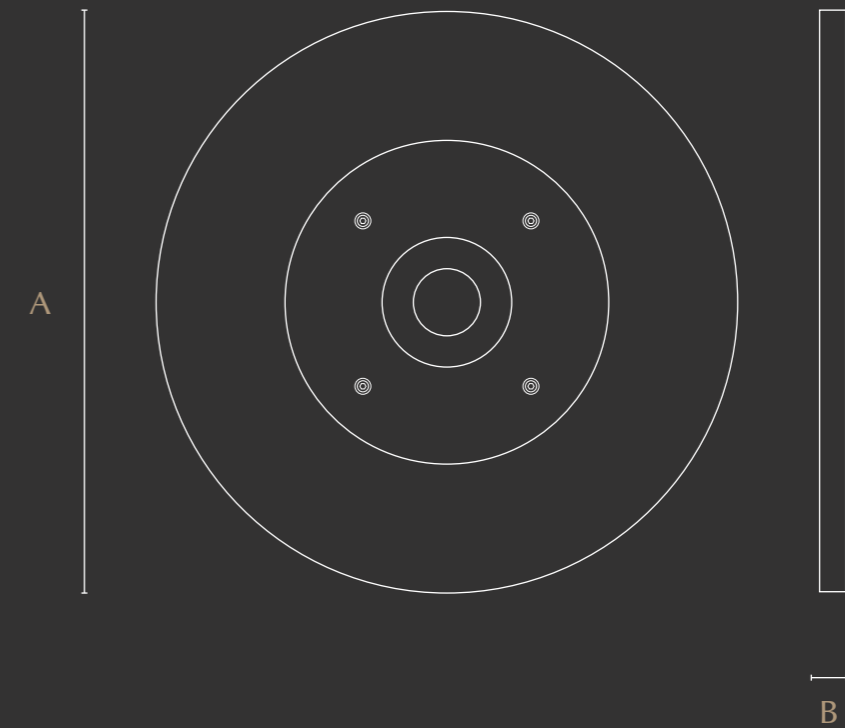

	Dimension A	Dimension B
1.5kg	120mm	22mm
2.5kg	165mm	22mm
5kg	220mm	22mm
10kg	325mm	18mm
15kg	405mm	18mm
20kg	455mm	18mm
25kg	455mm	22mm

Adjustable Bench

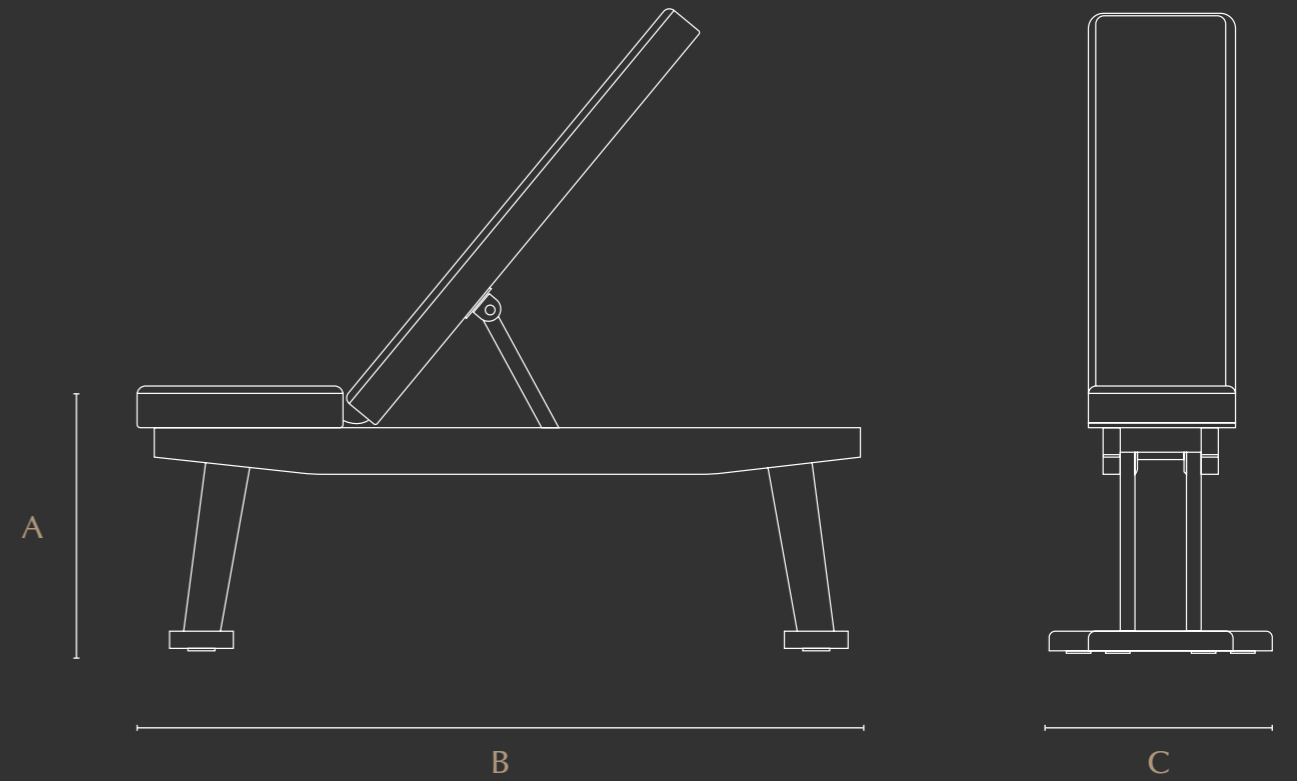

	Dimension A	Dimension B	Dimension C
Adjustable Bench	500mm (flat)	1,200mm	350mm

Folding Wall Bar

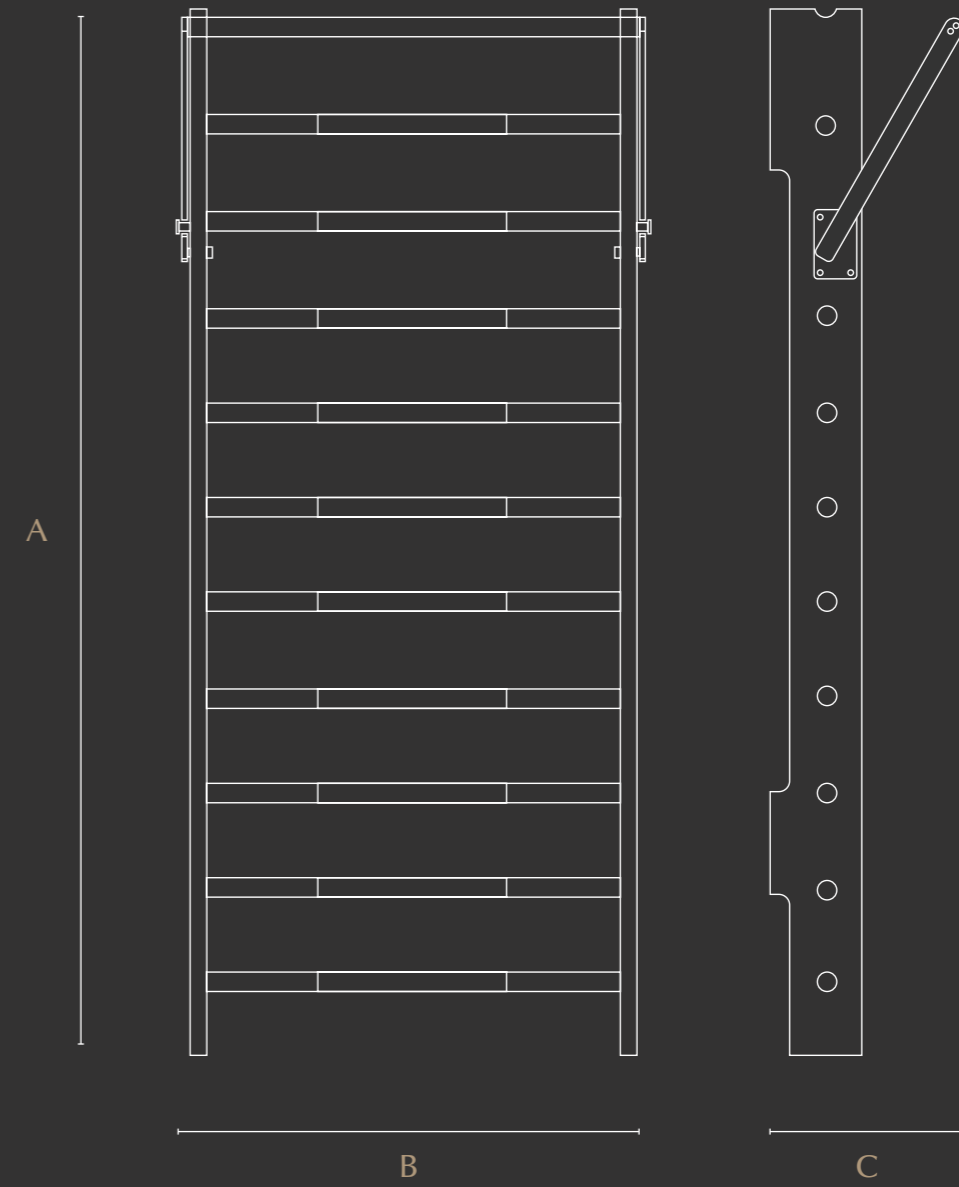

	Dimension A	Dimension B	Dimension C
Standard	2,100mm	940mm	180mm
Short	1,900mm	940mm	180mm

Wooden Plyo Box

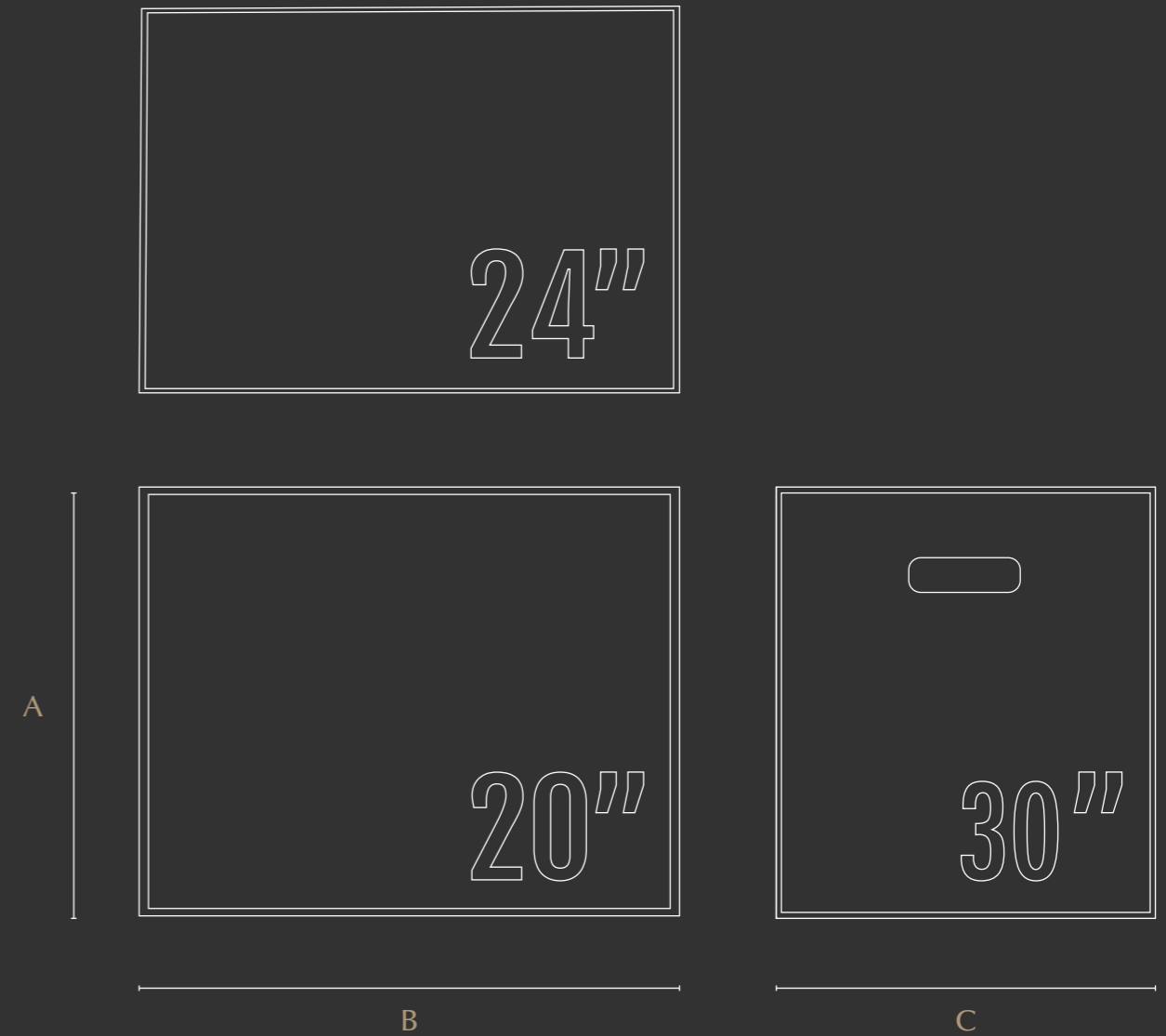

	Dimension A	Dimension B	Dimension C
Wooden Plyo Box	600mm	750mm	500mm

Exercise Ball Holder

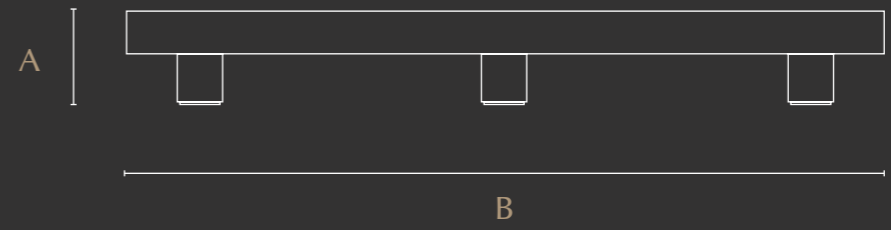

	Dimension A	Dimension B
Exercise Ball Holder	100mm	800mm

Dumbbell Wall Rack

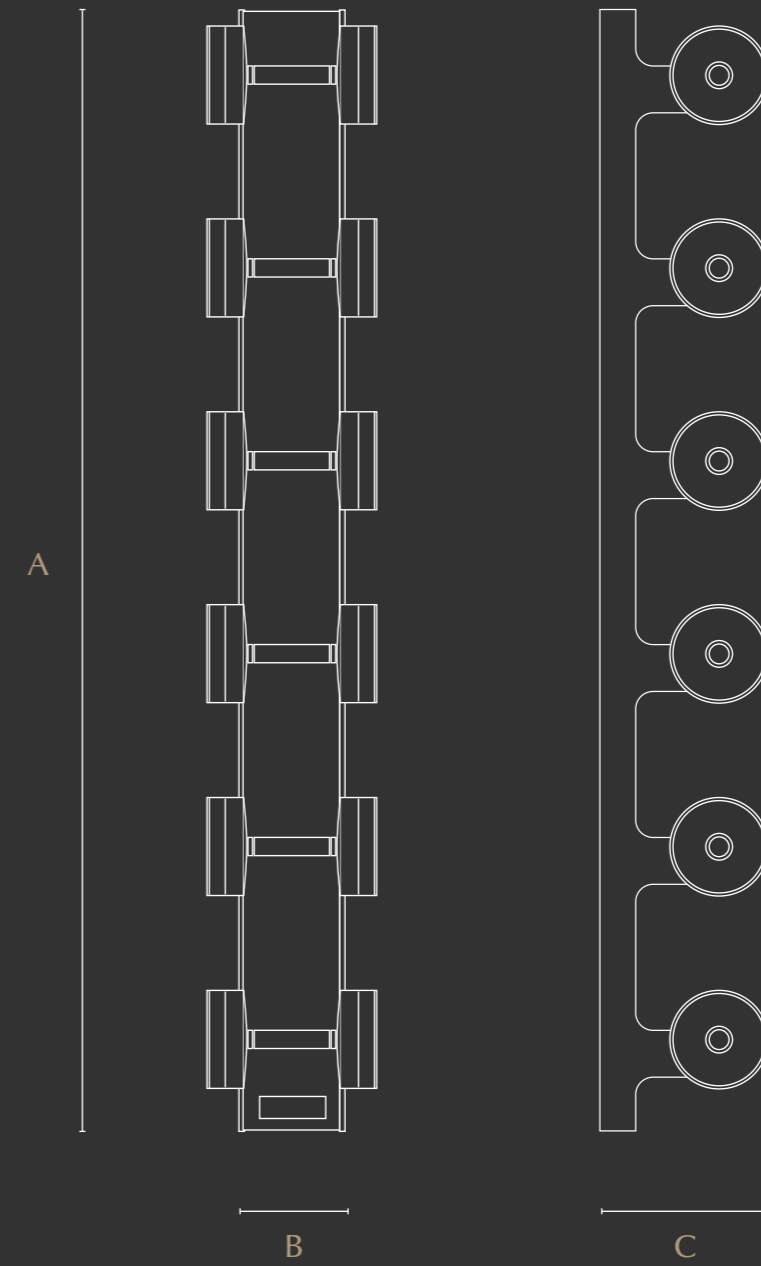

	Dimension A	Dimension B	Dimension C
3 Pairs	1,500mm	110mm	170mm
4 Pairs	1,550mm	110mm	170mm
5 Pairs	1,940mm	110mm	170mm

Dumbbell Tree Rack

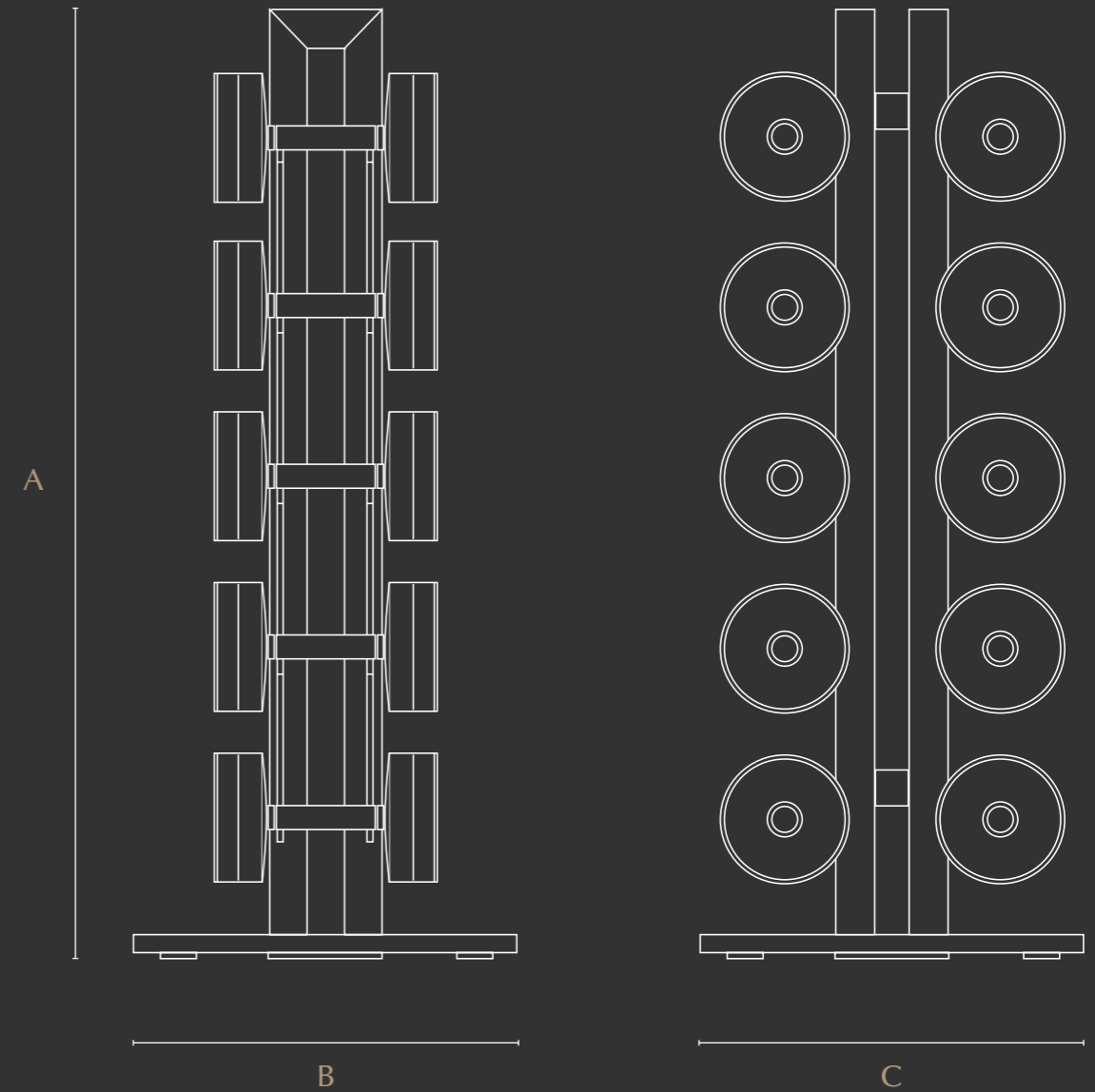

	Dimension A	Dimension B	Dimension C
5 Pairs	1,200mm	460mm	460mm
6 Pairs	1,400mm	490mm	490mm

Kettlebell Tree Rack

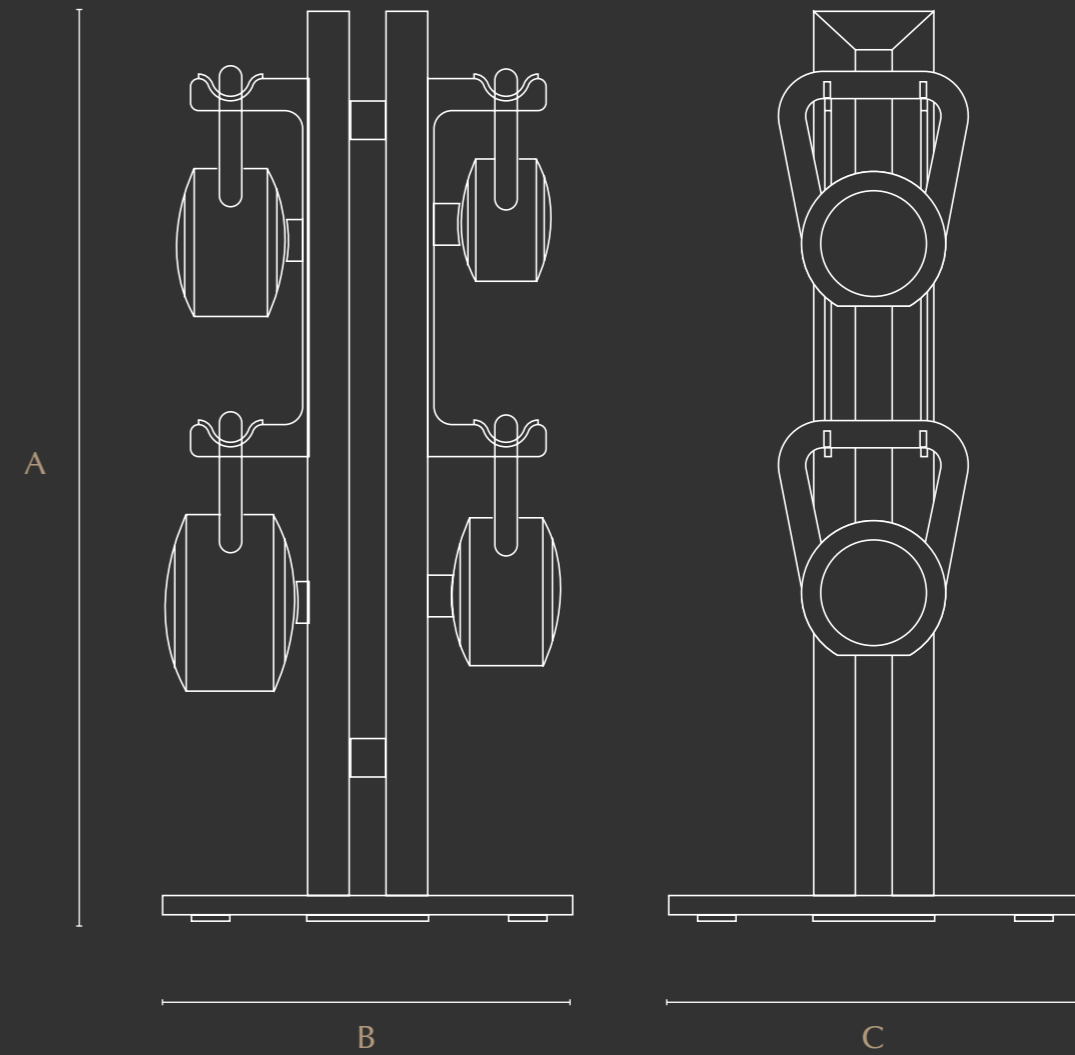

	Dimension A	Dimension B	Dimension C
4 Set	1,003mm	475mm	475mm

Kettlebell Wall Rack

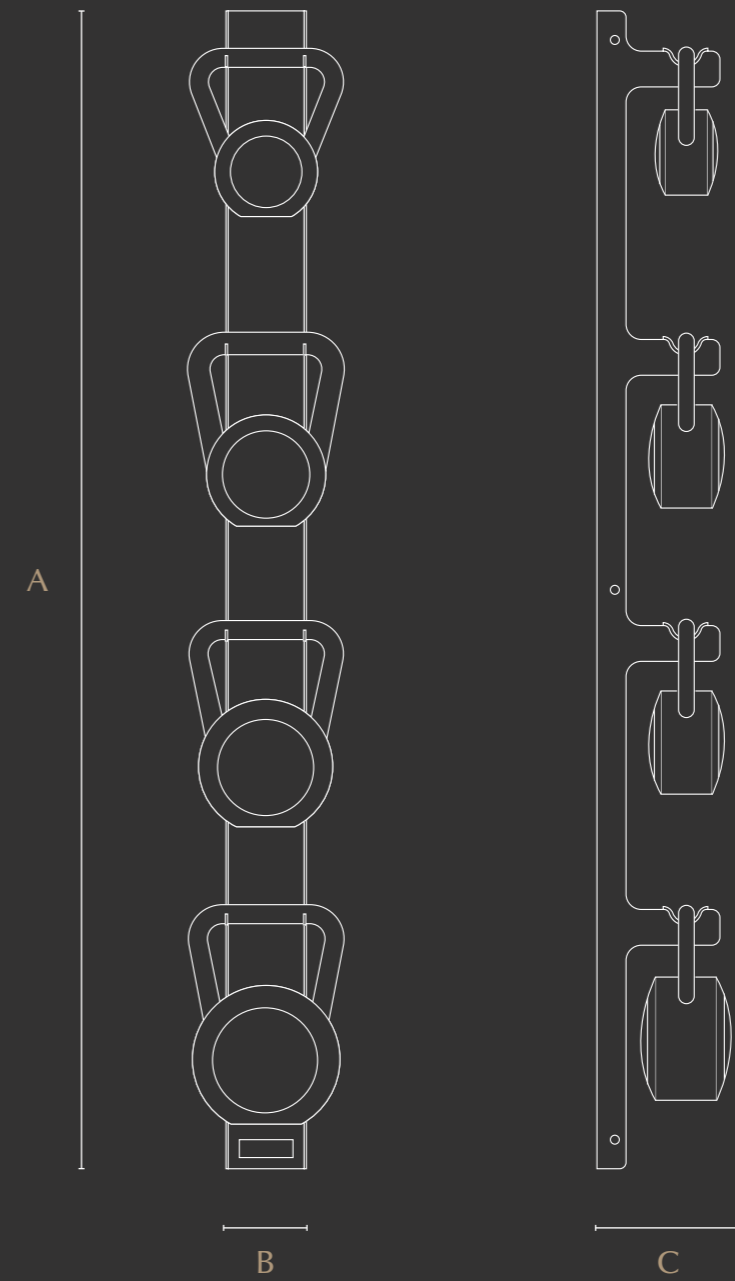

	Dimension A	Dimension B	Dimension C
4 Set	1,544mm	110mm	164mm

Horizontal Dumbbell Rack

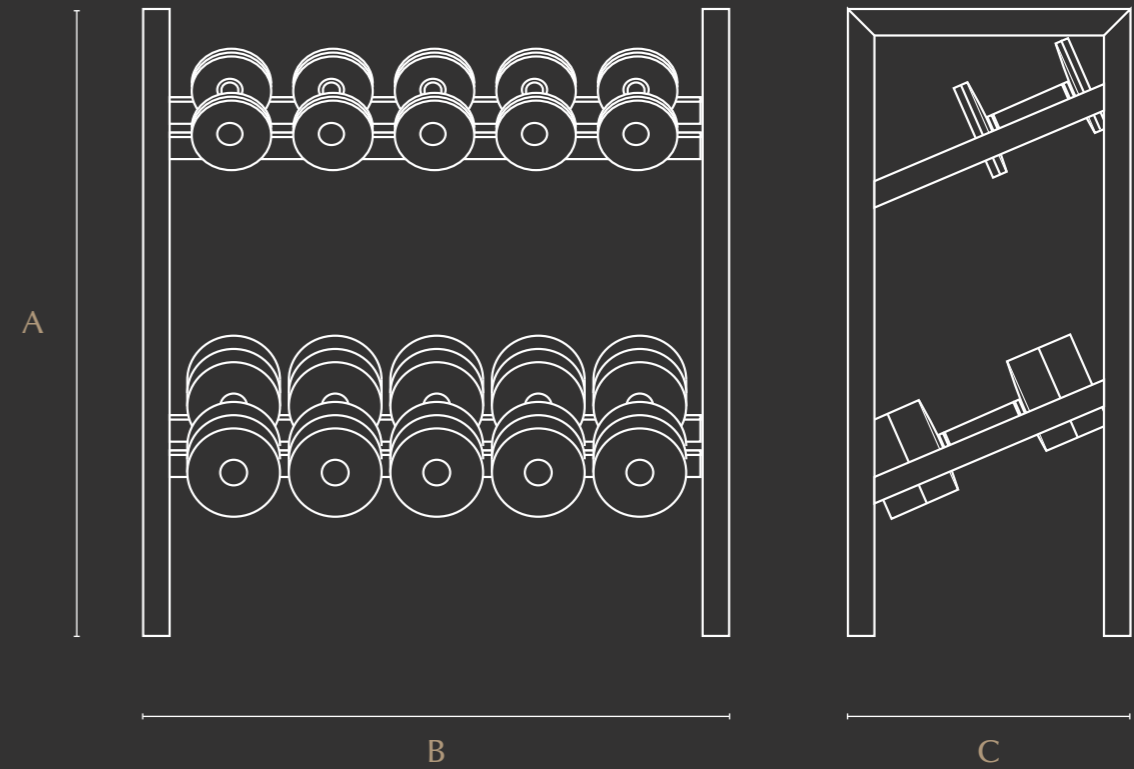

	Dimension A	Dimension B	Dimension C
5 Pairs	1,100mm	1,200mm	470mm
6 Pairs	1,100mm	1,200mm	470mm
10 Pairs	1,100mm	2,220mm	470mm
15 Pairs	1,100mm	2,220mm	470mm

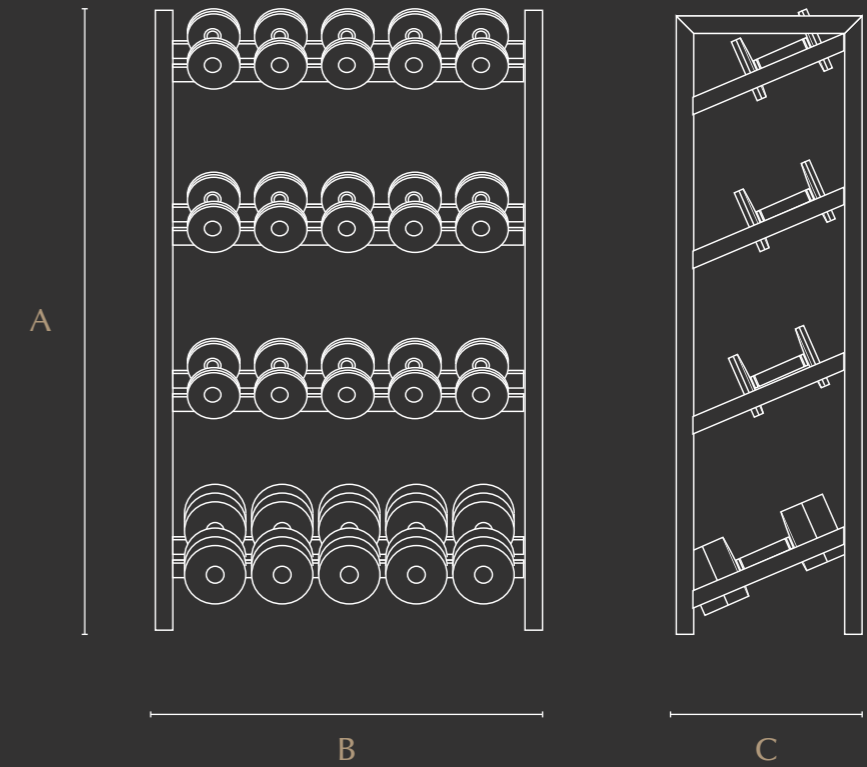
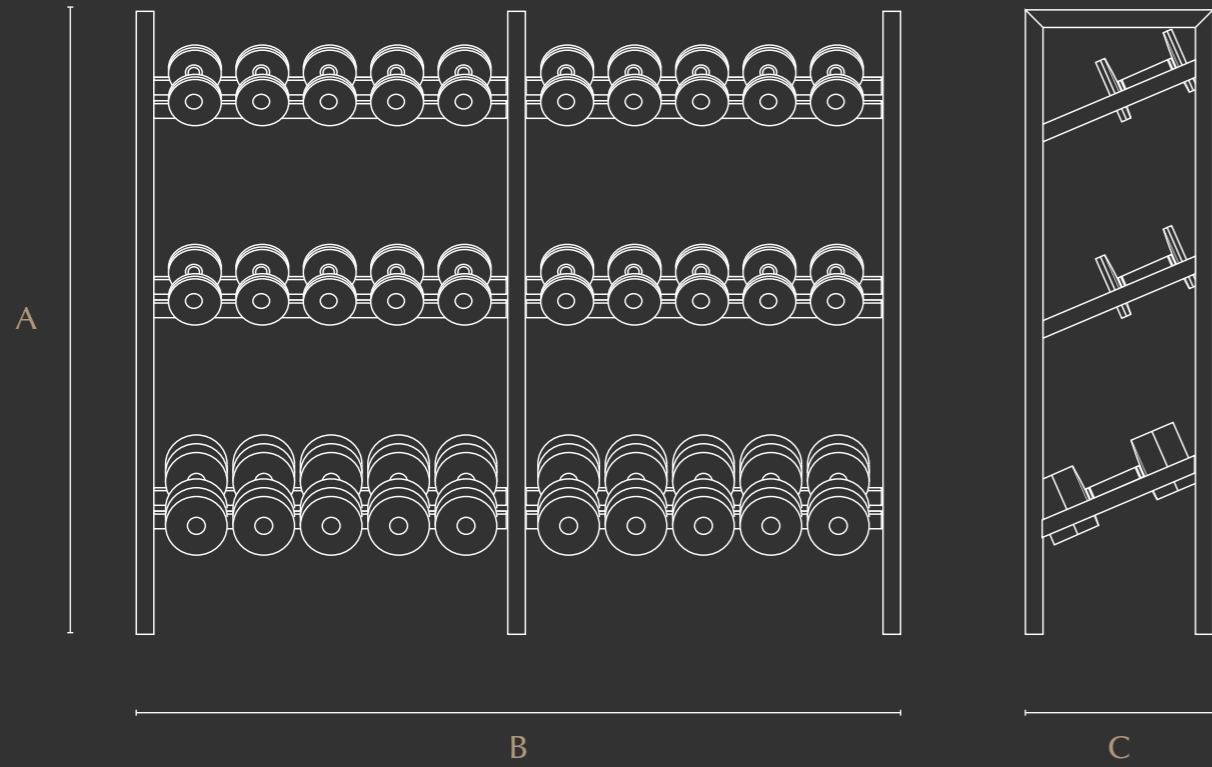

Dimension A Dimension B Dimension C

3 Tier 1,305mm 1,835mm 450mm

Dimension A Dimension B Dimension C

4 Tier 1,504mm 939.5mm 450mm

Wall Unit Complete Package

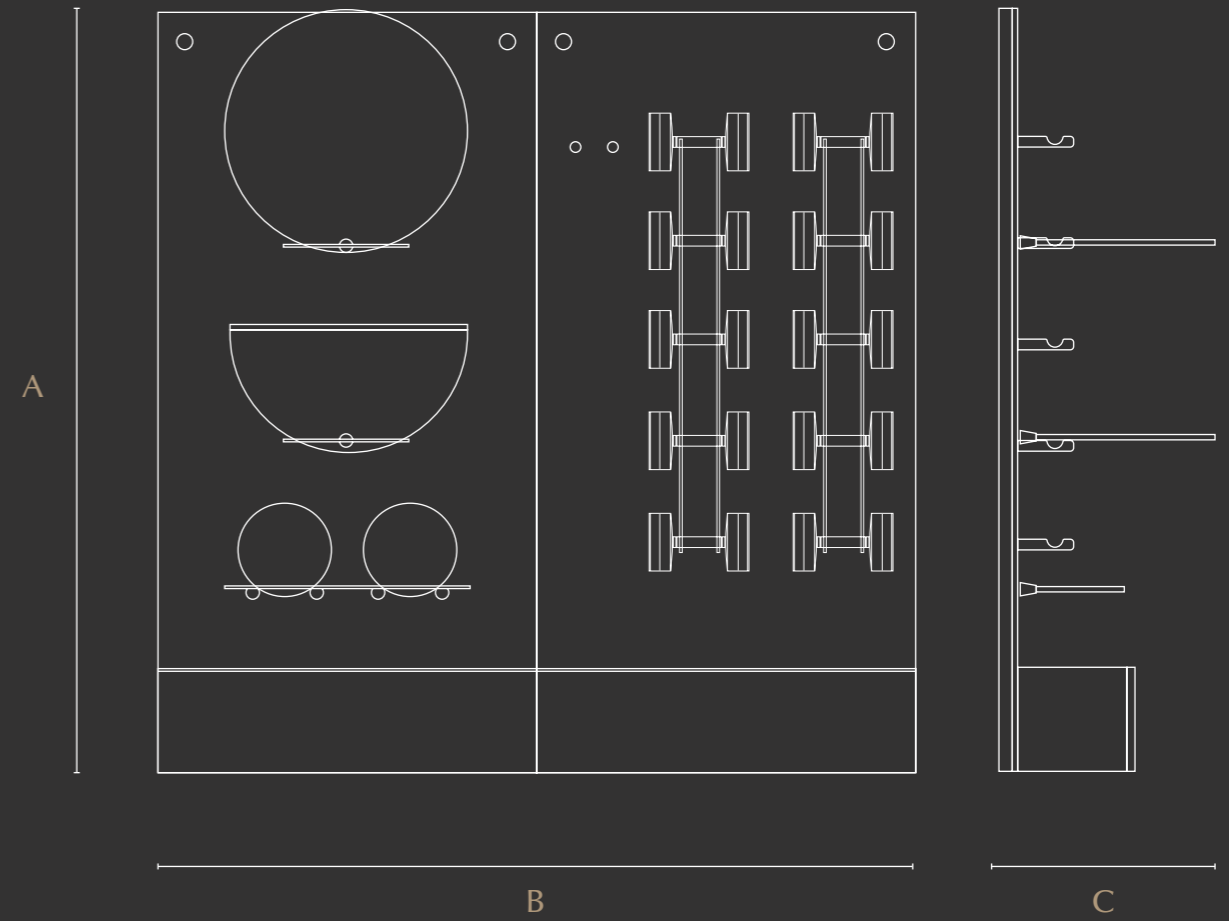

	Dimension A	Dimension B	Dimension C
1 Panel	2,000mm	1,000mm	360mm
2 Panel	2,000mm	2,000mm	360mm
3 Panel	2,000mm	3,000mm	360mm

Credenza Complete Package

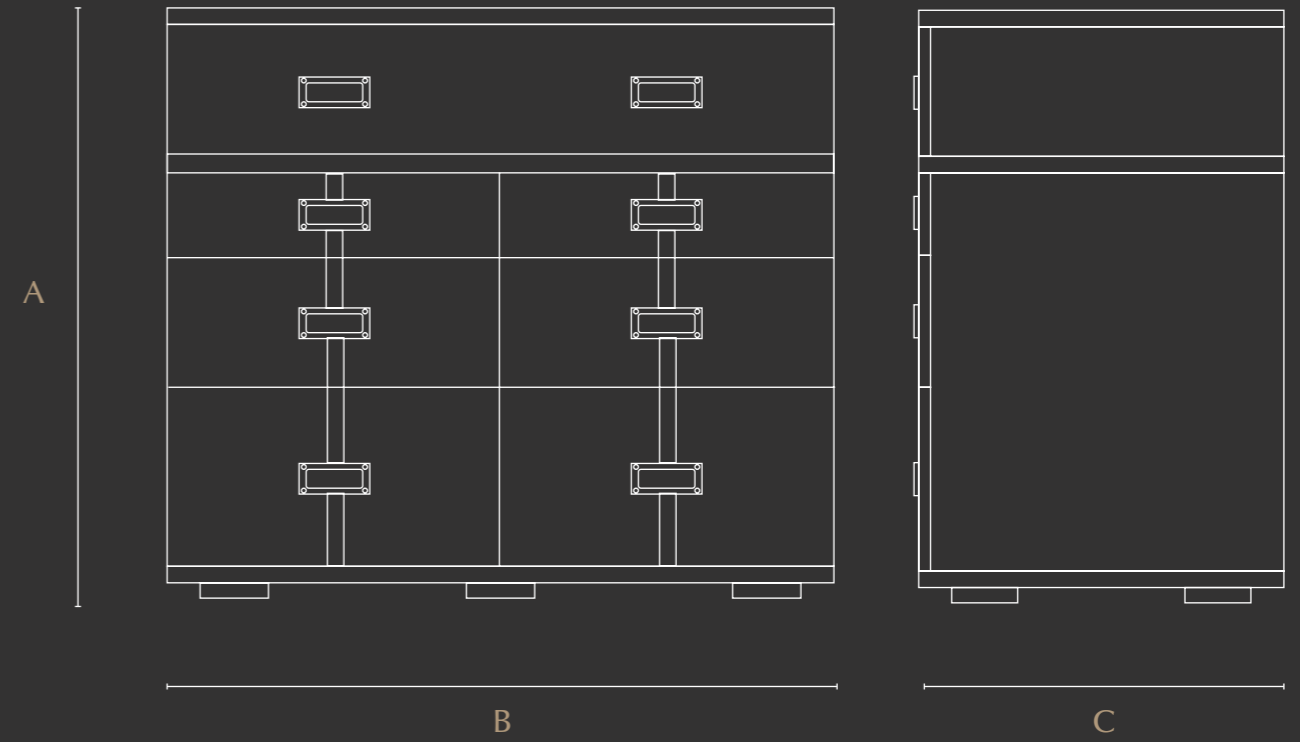
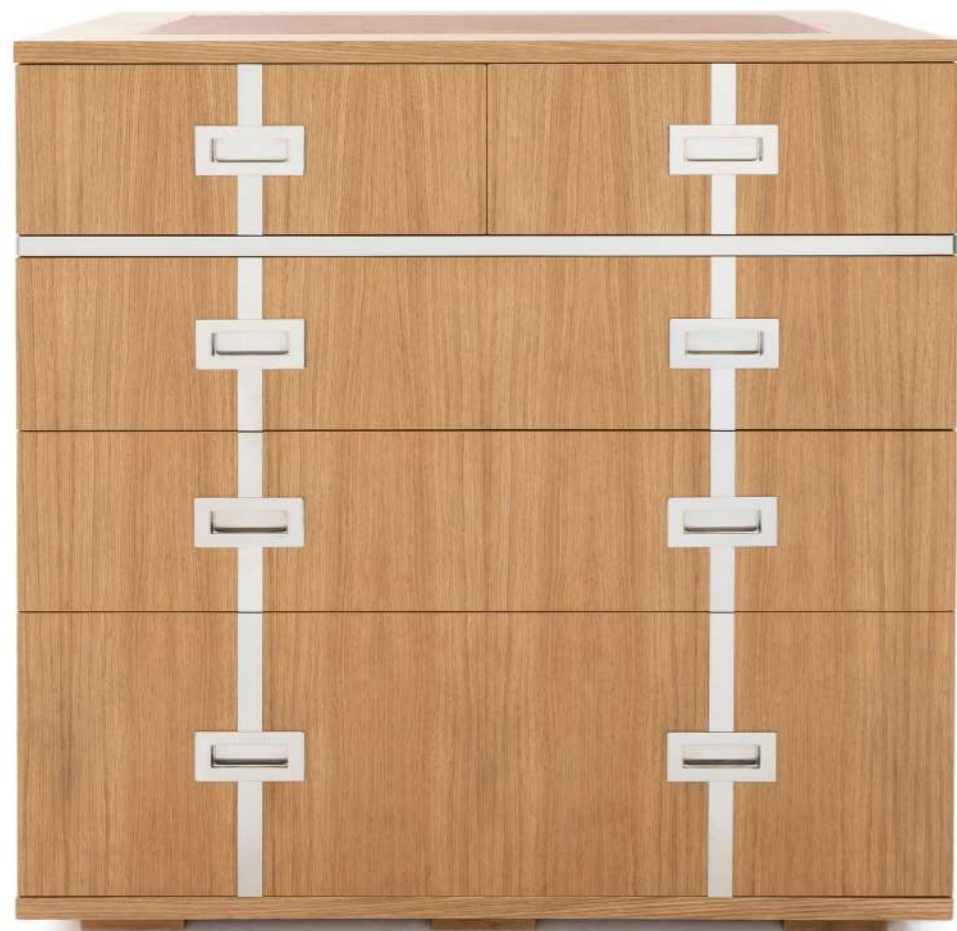

	Dimension A	Dimension B	Dimension C
Credenza	904mm	1,000mm	550mm

Designers Area

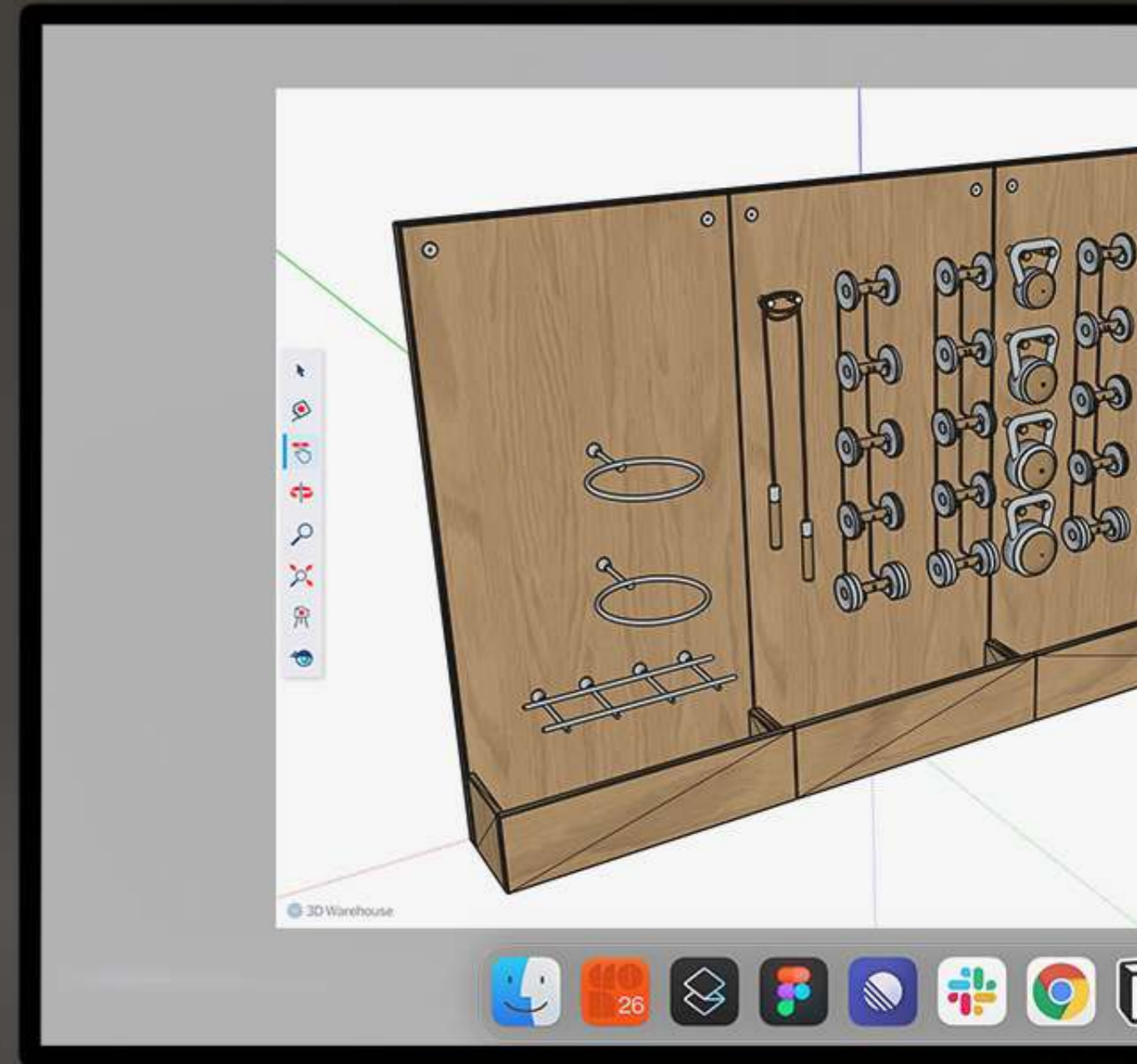

Designers Area

If you are an architect or profesional interior designer, then we would love to invite you to our Designers Area on our website, where you will find all of our 2D and 3D models for use in your schemes.

Filetypes available include DWG, DXF, STEP, 3DS and SKP
Please contact us for information on how to access and to request any custom drawings you may not find online.













P A R A G O N
S T U D I O

Spring 2025

London, UK

tel: +441225727959 | hello@paragonstudioco.uk | www.paragonstudio.co.uk